



Since 1972

In 1972 COSMEK realise and patent a pneumatic greaser with cartridge winning the silver medal at the 21st Bruxelles International Exhibition of Inventions.

From then on, by means of a continue and careful research, the firm has developed an high range of products that resolve problems of greasing, lubrication and refuelling.



Pneumatic Grease Gun COS-MEK

Code 1000

PNEUMATIC GREASE GUN COS-MEK

Main characteristics of this gun are:

- The use of a grease cartridge that seals and preserves the lubricant used.
- The pneumatic system that allows the use of all grease cartridge without the forming of air bubbles, in a clean and easy way to work.

The solid body in steel and aluminum, the quality of each parts guarantee reliability and endurance.

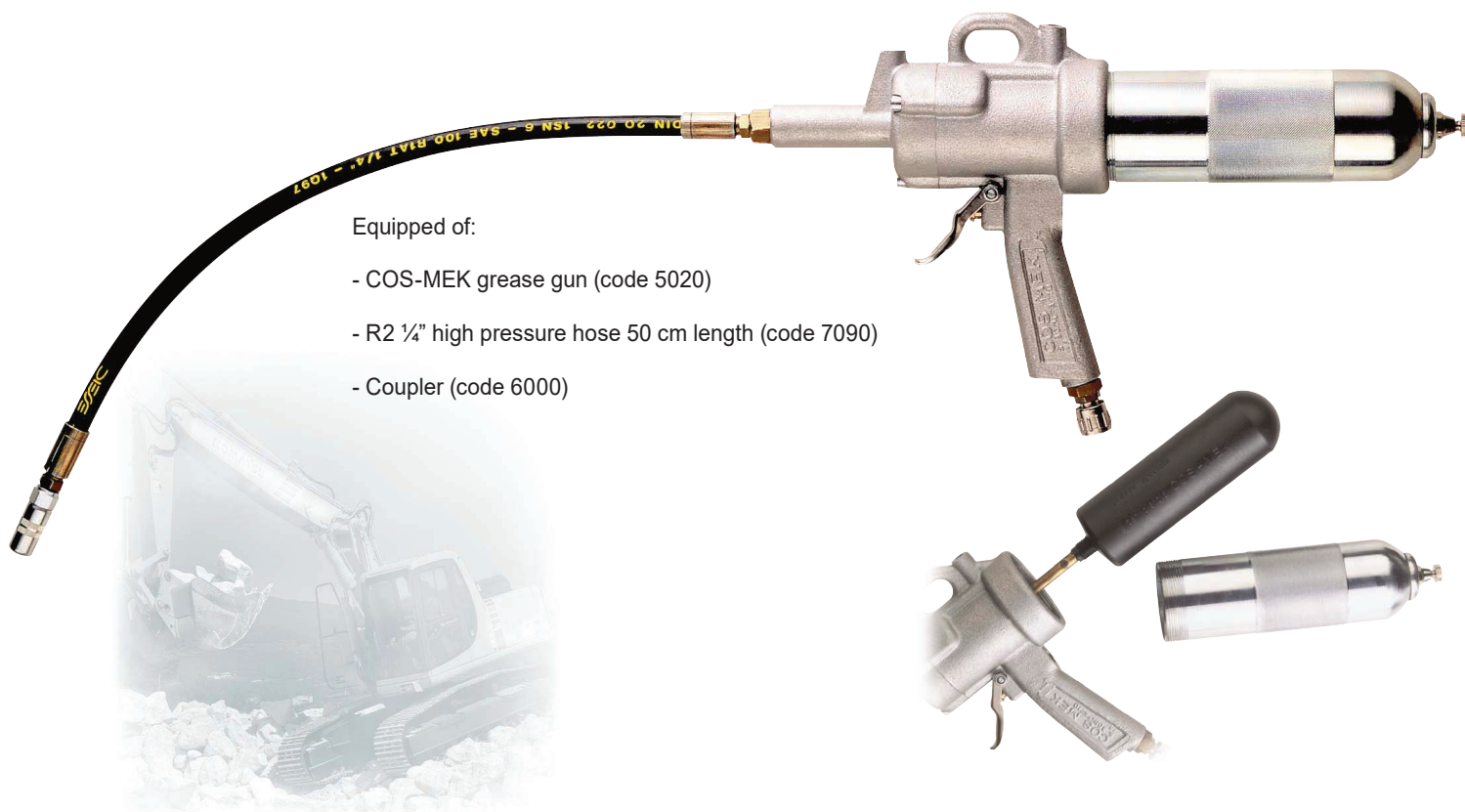

Equipped of:

- COS-MEK grease gun (code 5020)
- R2 1/4" high pressure hose 50 cm length (code 7090)
- Coupler (code 6000)



30 Pc. GREASE GUN CARTRIDGE PACKAGES FOR Code 1000
available with the following types of grease:

Code 8000 MULTIPURPOSE EP2

Use: multi purpose for bushings.

Code 8200 MOLY GREASE

Use: (with disulphide molybdenum)
transmission, joints couplings.

Code 8300 CONTACT

Use: Stringy grease, exceptionally
adhesive with high EP (Extreme Pressure)
and water repellent characteristics

Code 8400 FOOD GREASE

Use: White base oil thickened with Aluminium
Complex soaps, studied for the lubrication
of food processing and packaging machines.

Grease Kits



Code 1100

GREASE KIT for 20 Kg drums WITH TROLLEY

Equipped of:

- 5040 - Air-operated grease pump ratio 50:1 for 20 kg drums
- 7830 - Air lubricator and pressure regulator
- 5610 - 2 wheels trolley for 20 Kg drums
- 7020 - R2 ¼" distributing hose 6 m length
- 5950 - Grease gun with flexible pipe and coupler
- 7300 - Follower plate for drums internal diameter 290-310 mm
- 7400 - Drum cover diameter 315 mm



Code 1250

GREASE KIT for 50 Kg drums WITH TROLLEY (4 wheels trolley)

Equipped of:

- 5060 - Air-operated grease pump ratio 50:1 for 50 kg drums
- 7830 - Air lubricator and pressure regulator
- 5625 - 4 wheels trolley for 50 Kg drums
- 56200 - Bracket pump
- 7020 - R2 ¼" distributing hose 6 m length
- 5950 - Grease gun with flexible pipe and coupler
- 7310H - Follower plate, **HEAVY**, for drums internal diameter 380 mm
- 7410 - Drum cover diameter 400 mm

Grease Kits



Code 1300

GREASE KIT for 200 Kg drums WITH TROLLEY

Equipped of:

- 5080 - Air-operated grease pump ratio 50:1 for 200 kg drums
- 7830 - Air lubricator and pressure regulator
- 5600 - 4 wheels trolley for 200 Kg drums
- 7020 - R2 ¼" distributing hose 6 m length
- 6100 - Straight swivel coupler
- 5950 - Grease gun with flexible pipe and coupler
- 7320H - Follower plate, **HEAVY**, for drums internal diameter 570 mm
- 7420 - Drum cover diameter 600 mm



Code 1350

GREASE KIT for 200 Kg drums WITH TROLLEY AND HOSE REEL

Equipped of:

- 5080 - Air-operated grease pump ratio 50:1 for 200 kg drums
- 7830 - Air lubricator and pressure regulator
- 5605 - 4 wheels trolley with brake for 200 Kg drums
- 71900 - Automatic hose-reel with distributing hose 15 m length
- 7115 - R2 ¼" connection hose among pump and hose-reel 2 m length
- 5950 - Grease gun with flexible pipe and coupler
- 6110 - Triple swivel coupler
- 7320H - Follower plate, **HEAVY**, for drums internal diameter 570 mm
- 7420 - Drum cover diameter 600 mm

Grease Kits



Code 1400

GREASE KIT for 200 Kg Drums

Equipped of:

- 5080 - Air-operated grease pump ratio 50:1 for 200 kg drums
- 7830 - Air lubricator and pressure regulator
- 7020 - R2 ¼" distributing hose 6 m length
- 5950 - Grease gun with flexible pipe and coupler
- 6100 - Straight swivel coupler
- 7320H - Follower plate, **HEAVY**, for drums internal diameter 570 mm
- 7420 - Drum cover diameter 600 mm



Code 1500

GREASE KIT for 200 Kg drums AND HOSE REEL

Equipped of:

- 5080 - Air-operated grease pump ratio 50:1 for 200 kg drums
- 7830 - Air lubricator and pressure regulator
- 71900 - Automatic hose-reel with distributing hose 15 m length
- 7115 - R2 ¼" connection hose among pump and hose-reel 2 m length
- 5950 - Grease gun with flexible pipe and coupler
- 6110 - Triple swivel coupler
- 7320H - Follower plate, **HEAVY**, for drums internal diameter 570 mm
- 7420 - Drum cover diameter 600 mm

Hand pumps for greasing



Code 1750

Barrel Hand pump for grease

- Capacity Barrell: 16 Kg
- stroke flow rate: 8 gr
- output pressure: 200 bar
- with handle
- hose length 1,5 m
- cock and rigid pipe with coupler



Code 1720

Grease hand pump for 18/20 Kg drums

- Hand pump
- Drum cover Ø 315 mm with fixing screws
- Follower plate Ø 260 mm
- Rubber hose 1,5 m length.
- cock and rigid pipe with coupler

Code 5000

HAND OPERATED GREASE PUMP FOR 600 GR. CARTRIDGE

Professional model, it works with 600 gr cartridge (external diameter 55 mm-length 300 mm).

Composed by:

- 5005 600 gr hand greaser .
- 7090 R2 ¼" high pressure hose 50 cm length
- 6000 Coupler (made in Germany)



25 Pc. GREASE GUN CARTRIDGE PACKAGES FOR Code 5005 in the following types: (external diameter 55 mm - lenght 300 mm)

Code 9000 MULTIPURPOSE EP2

Use: multi purpose for bushings

Code 9200 MOLY GREASE

Use: (with disulphide molybdenum) transmission, joints couplings.

Code 9300 CONTACT

Use: Stringy grease, exceptionally adhesive with high EP (Extreme Pressure) and water repellent characteristics

Code 9400 FOOD GREASE

Use: White base oil thickened with Aluminium Complex soaps, studied for the lubrication of food processing and packaging machines.

Hand pump for grease operated with one hand

Code 5001

Hand pump operated with one hand

Ideal to reach inaccessible areas. It is equipped with a special system that allows quick change of type of pumping high pressure or high capacity.

It works with 400 gr commercial cartridges.
cartridges Dimensions: diam. 52 mm - length 245 mm.



Composed by:

- 5006 one hand greaser pump 400 gr capacity
- 7090 R2 1/4" high pressure hose 50 cm length.
- 6000 Coupler

25 Pc. GREASE GUN CARTRIDGE PACKAGES FOR Code 5006 in the following types: (external diameter 52 mm - length 245 mm)

Code 9001 MULTIPURPOSE EP2

Use: multi purpose for bushings

Code 9201 MOLY GREASE

Use: (with disulphide molybdenum) transmission, joints couplings.

Code 9301 CONTACT

Use: Stringy grease, exceptionally adhesive with high EP (Extreme Pressure) and water repellent characteristics

Code 9401 FOOD GREASE

Use: White base oil thickened with Aluminium Complex soaps, studied for the lubrication of food processing and packaging machines.



Refilling pump for screw cartridges

Kit with manual pump for refilling grease cartridges with threaded connection.

Complete with drum cover, grease pressing disc with membrane and coupling tip.

Can be used for greases up to NLGI 2.

Technical data	Art. 5126	Art. 5127	Art. 5128
Stroke flow rate	40 g	40 g	40 g
Sucker diameter	40 mm	40 mm	40 mm
Length of float	335 mm	450 mm	750 mm
Cover diameter	283 mm	330 mm	400 mm
Disc diameter	275 mm	310 mm	390 mm
Drums diameter	240-283 mm	290-310 mm	360-400
For capacity drums	18 Kg	20 Kg	50 Kg
Weight	5 Kg	6 Kg	8 Kg



Art. 9506

Empty cartridge
with cap

Hand pump for grease

Art. 5002

HAND OPERATED GREASE PUMP FOR 400 GR. CARTRIDGE for screw cartridges

Professional model, it works with 400 gr cartridge.

Composed by:

- 5003 400 gr hand greaser .
- 7090 R2 1/4" high pressure hose 50 cm length
- 6000 Coupler (made in Germany)



GREASE GUN CARTRIDGE PACKAGES FOR Code 5002 in the following types:

Code 9052 MULTIPURPOSE EP2

Use: multi purpose for bushings

Code 9252 MOLY GREASE

Use: (with disulphide molybdenum) transmission, joints couplings.

Code 9353 Use: Stringy grease, exceptionally adhesive with high EP (Extreme Pressure) and water repellent characteristics

Grease transfer kit

INDUSTRIAL HIGH PERFORMANCE AIR OPERATED PUMPS

A pneumatic high performance pump recommended for low and medium viscosity filling of grease for single application, where is requested an high volume delivery. The heavy follower plate prevents the formation of air pockets and assure the suction of all grease from the drum.



Grease gun for high flow
(cod.593710)

Compression ratio	R = 6 : 1
Pressure use	6 - 8 bar
Flow rate (with grease NLGI 2 at 15°C)	4 Kg/min
Air consumption at 6 bar	100 l/min
Air input attack	1/4"
Grease output attack	3/4"
Use for drums	180 kg

Code 4700 GREASE TRANSFER KIT

Standard Equipped: Air-operated grease pump ratio 6:1 for 200 kg drums, Air lubricator and pressure regulator, Drum cover diam. 600 mm, Follower plate for drums internal diameter 570 mm

Electronic dispenser for oil and grease

A volumetric measurement system controls the amount of lubricant which is supplied from upstream, blocking the supply pump once reached the pre-set value.

The operator sets on the batcher display the value of the quantity to deliver (es. 3 litres or 0,2 litres ecc.). Through the button under the dispenser or a remote button (Microswitch or pedal, or other) delivery is controlled in the amount set.

At the end of the distribution the system automatically stops waiting for a new command output.



Hand pumps for grease transfer

REFILLING KIT FOR CENTRALISED PLANTS

For the refilling of centralised plants with oil and grease until NLGI2; suitable to apply directly on the original 18/20 kg drums.



Code 1650

REFILLING GREASE KIT for 20 Kg drums WITH TROLLEY

Equipped of:

- 5015 Hand pump to transfer grease
- 7301 Cover drum and clamping screws
- 5610 2 wheels trolley for 20 Kg drums
- 7005 Ø 3/8" distributing hose 2 m length
- 7015 Quick coupler Parker

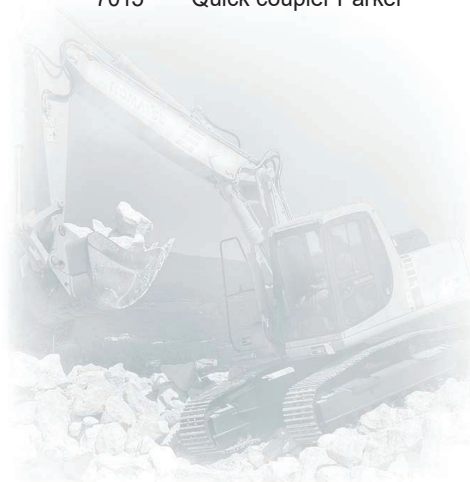

Oil kit

Code 2200

OIL KIT ratio 3:1 for 200 Kg drums

Equipped of:

- 5100 - Air-operated oil pump ratio 3:1 for 200 kg drums
- 7830 - Air lubricator and pressure regulator
- 7130 - R1 ½" distributing hose 4 m length
- 5930 - Oil gun with electronic digital meter

Code 2260

OIL KIT ratio 6:1 for 200 Kg drums

Equipped of:

- 5200 - Air-operated oil pump ratio 6:1 for 200 kg drums
- 7830 - Air lubricator and pressure regulator
- 7130 - R1 ½" distributing hose 4 m length
- 5930 - Oil gun with electronic digital meter



Code 2300

OIL KIT ratio 3:1 for 200 Kg drums with HOSE REEL

Equipped of:

- 5100 - Air-operated oil pump ratio 3:1 for 200 kg drums
- 7830 - Air lubricator and pressure regulator
- 71901 - Automatic hose reel with distributing hose 15 m length
- 7120 - R1 ½" connecting hose pump/hose reel 2 m length
- 5930 - Oil gun with electronic digital meter



Code 2350

OIL KITS ratio 6:1 for 200 Kg drums with HOSE REEL

Equipped of:

- 5200 - Air-operated oil pump ratio 6:1 for 200 kg drums
- 7830 - Air lubricator and pressure regulator
- 71901 - Automatic hose reel with distributing hose 15 m length
- 7120 - R1 ½" connecting hose pump/hose reel 2 m length
- 5930 - Oil gun with electronic digital meter

Oil kit

Code 2500

OIL KIT ratio 3:1 for 200 Kg drums WITH TROLLEY

Equipped of:

- 5100 - Air-operated oil pump ratio 3:1 for 200 kg drums
- 7830 - Air lubricator and pressure regulator
- 5600 - 4 wheels trolley for 200 Kg drums
- 7130 - R1 ½" distributing hose 4 m length
- 5930 - Oil gun with electronic digital meter

Code 2560

OIL KIT ratio 6:1 for 200 Kg drums WITH TROLLEY

Equipped of:

- 5200 - Air-operated oil pump ratio 6:1 for 50 kg drums
- 7830 - Air lubricator and pressure regulator
- 5625 - 4 wheels trolley for 50 Kg drums
- 7130 - R1 ½" distributing hose 4 m length
- 5930 - Oil gun with electronic digital meter

Code 2600

OIL PNEUMATIC DISTRIBUTOR ratio 3:1 for 200 Kg drums

Equipped of:

- 5120 - Air-operated oil pump ratio 3:1 wall mounted model
- 7830 - Air lubricator and pressure regulator
- 5600 - 4 wheels trolley for 200 Kg drums
- 7130 - R1 ½" distributing hose 4 m length
- 7255 - Ø 3/4" suction rigid pipe for 200 Kg drums
- 7258 - Ø 3/4" connecting hose 2 m length
- 5930 - Oil gun with electronic digital meter

Code 2650

OIL PNEUMATIC DISTRIBUTOR ratio 6:1 for 200 Kg drums

Equipped of:

- 5220 - Air-operated oil pump ratio 6:1 wall mounted model
- 7830 - Air lubricator and pressure regulator
- 5600 - 4 wheels trolley for 200 Kg drums
- 7130 - R1 ½" distributing hose 4 m length
- 7254 - Ø 3/4" suction rigid pipe for 200 Kg drums
- 7258 - Ø 3/4" connecting hose 2 m length
- 5930 - Oil gun with electronic digital meter

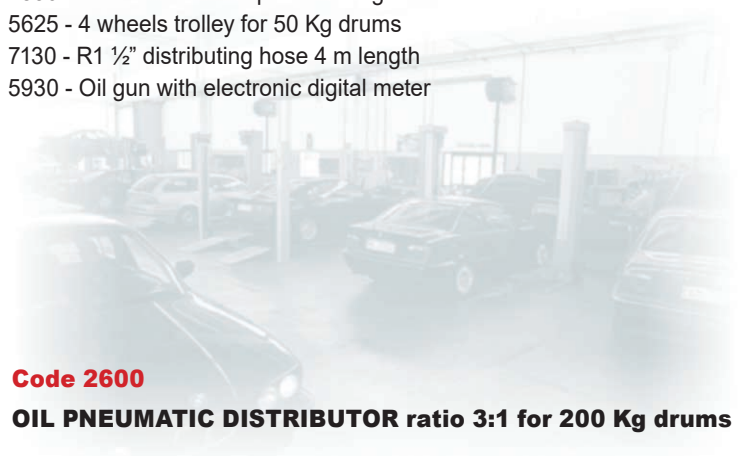

Oil kit

Code 2700

OIL KIT ratio 3:1 for 200 Kg drums WITH TROLLEY and HOSE REEL

Equipped of:

- 5100 - Air-operated oil pump ratio 3:1 for 200 kg drums
- 7830 - Air lubricator and pressure regulator
- 5605 - 4 wheels trolley for 200 Kg drums with brake
- 71901 - Automatic hose reel with distributing hose 15 m length
- 7120 - R1 ½" connecting hose pump/hose reel 2 m length
- 5930 - Oil gun with electronic digital meter

Code 2750

OIL KIT ratio 6:1 for 200 Kg drums WITH TROLLEY and HOSE REEL

Equipped of:

- 5200 - Air-operated oil pump ratio 6:1 for 200 kg drums
- 7830 - Air lubricator and pressure regulator
- 5605 - 4 wheels trolley for 200 Kg drums with brake
- 71901 - Automatic hose reel with distributing hose 15 m length
- 7120 - R1 ½" connecting hose pump/hose reel 2 m length
- 5930 - Oil gun with electronic digital meter

Code 3100

OIL HAND DISTRIBUTOR for 200 Kg drums with ELECTRONIC DIGITAL METER

Equipped of:

- 5197 - 0,2 litres/cycle hand pump with electronic digital meter
- 5600 - 4 wheels trolley for 200 Kg drums
- 7255 - Ø 3/4" suction rigid pipe for 200 Kg drums
- 7258 - Ø 3/4" connecting hose 2 m length
- 7262 - Ø 3/4" distributing hose 3 m length
- 5915 - Oil gun with rigid terminal

Code 3150

OIL HAND DISTRIBUTOR for 50 Kg drums with ELECTRONIC DIGITAL METER

Equipped of:

- 5197 - 0,2 litres/cycle hand pump with electronic digital meter
- 5625 - 4 wheels trolley for 50 Kg drums
- 7254 - Ø 3/4" suction rigid pipe for 50 Kg drums
- 7258 - Ø 3/4" connecting hose 2 m length
- 7262 - Ø 3/4" distributing hose 3 m length
- 5915 - Oil gun with rigid terminal



Oil kit



Code 3600

OIL WALL KIT ratio 3:1 with HOSE REEL

Equipped of:

- 5120 - Air-operated oil pump ratio 3:1 wall mounted model
- 7830 - Air lubricator and pressure regulator
- 7915 - Wall fixing bracket
- 71901 - Automatic hose reel with distributing hose 15 m. length
- 7120 - R1 1/2" connecting hose pump/hose reel 2 m length
- 5930 - Oil gun with electronic digital meter
- 7255 - Ø 3/4" suction rigid pipe for 200 Kg drums
- 7258 - Ø 3/4" connecting hose 2 m. length

Code 3700

OIL WALL KIT ratio 6:1 with HOSE REEL

Equipped of:

- 5220 - Air-operated oil pump ratio 6:1 wall mounted model
- 7830 - Air lubricator and pressure regulator
- 7915 - Bracket pump for wall fixing
- 71901 - Automatic hose reel with distributing hose 15 m. length
- 7120 - R1 1/2" connecting hose pump/hose reel 2 m length
- 5930 - Oil gun with electronic digital meter
- 7255 - Ø 3/4" suction rigid pipe for 200 Kg drums
- 7258 - Ø 3/4" connecting hose 2 m length



Code 3750

OIL KIT ratio 3:1 for 1000 litres tanks

Equipped of:

- 5120 - Air operated pump ratio 3:1 wall mounted model
- 7830 - Air lubricator and pressure regulator
- 791510 - Bracket pump
- 3245 - Suction hose with bottom connection
- 7130 - R1 1/2" distributing hose 4 m length
- 5930 - Oil gun with electronic digital meter



Code 3750

OIL KIT ratio 6:1 for 1000 litres tanks

Equipped of:

- 5220 - Air operated pump ratio 6:1 wall mounted model
- 7830 - Air lubricator and pressure regulator
- 791510 - Bracket pump
- 3245 - Suction hose with bottom connection
- 7130 - R1 1/2" distributing hose 4 m length
- 5930 - Oil gun with electronic digital meter

Oil kit



Code 22001

OIL KIT ratio 3:1 for 1000 litres tanks

Equipped of:

- 5130 - Air-operated oil pump ratio 3:1 for 1000 litres tank
- 7830 - Air lubricator and pressure regulator
- 7130 - R1 ½" distributing hose 4 m length
- 5930 - Oil gun with electronic digital meter

Code 22002

OIL KIT ratio 6:1 for 1000 litres tanks

Equipped of:

- 5230 - Air-operated oil pump ratio 6:1 for 1000 litres tank
- 7830 - Air lubricator and pressure regulator
- 7130 - R1 ½" distributing hose 4 m length
- 5930 - Oil gun with electronic digital meter

Code 23001

OIL KIT ratio 3:1 for 1000 litres tanks with HOSE REEL

Equipped of:

- 5130 - Air-operated oil pump ratio 3:1 for 1000 litres tanks
- 7830 - Air lubricator and pressure regulator
- 71901 - Automatic hose reel with distributing hose 15 m length
- 7120 - R1 ½" connecting hose pump/hose reel 2 m length
- 5930 - Oil gun with electronic digital meter

Code 23002

OIL KITS ratio 6:1 for 1000 litres tanks with HOSE REEL

Equipped of:

- 5230 - Air-operated oil pump ratio 6:1 for 1000 litres tanks
- 7830 - Air lubricator and pressure regulator
- 71901 - Automatic hose reel with distributing hose 15 m length
- 7120 - R1 ½" connecting hose pump/hose reel 2 m length
- 5930 - Oil gun with electronic digital meter



Electrical Oil kit

Code 2800

OIL KIT ELECTRICAL DISTRIBUTOR - 9 litres/min

Equipped of:

- 5435 - 230 VAC oil electropump - 9 litres/min
- 5600 - 4 wheels trolley for 200 Kg drums
- 7130 - R1 ½" distributing hose 4 m length
- 7255 - Ø 3/4" suction rigid pipe for 200 Kg drums
- 7258 - Ø 3/4" connecting hose 2 m length
- 5930 - Oil gun with electronic digital meter



40 litres/min

Code 2850

OIL KIT ELECTRICAL DISTRIBUTOR - 40 litres/min

Equipped of:

- 5445 - 230 VAC oil electropump - 40 litres/min
- 5600 - 4 wheels trolley for 200 Kg drums
- 7260 - Distributing hose 4 m length
- 7255 - Ø 3/4" suction rigid pipe for 200 Kg drums
- 7258 - Ø 3/4" connecting hose 2 m length
- 593710 - High flow Oil gun.



OPTIONAL ALTERNATIVE

Code 5937

High flow Oil gun with digital meter.

Electrical Oil kit



Code 3550

**OIL KIT ELECTRICAL DISTRIBUTOR 9 litres/min
to be mounted on 1000 litres IBC TANK**

Equipped of:

- 5440 - 230 VAC oil electropump - 9 litres/min
- 7910 - Support pump panel
- 3245 - Suction hose with bottom connection
- 7130 - R1 ½" distributing hose 4 m length
- 5930 - Oil gun with electronic digital meter



Code 3560

**OIL KIT ELECTRICAL DISTRIBUTOR 40 litres/min
to be mounted on 1000 lt IBC TANK**

Equipped of:

- 5445 - 230 VAC oil electropump - 40 litres/min
- 7910 - Support pump panel
- 3245 - Suction hose with bottom connection
- 7260 - Distributing hose 4 m length
- 5937 - High flow Oil gun with digital meter.

OPTIONAL ALTERNATIVE

Code 593710
High flow Oil gun.



Oil hand pump

Manual pump for transferring **lubricating oil** and **pure antifreeze liquid** suitable for commercial 200 liter drums. Made of steel and aluminum, sturdy and easy to use. It equipped with a steel suction tube and a 1.5 meter long delivery tube. with curved spout, drip fitting to be applied to the stem.

Code 3200

Single-acting manual pump.
Flow rate 0.5 liters for pumping cycle.



0,5 litri
for pumping
cycle.

Oil hand pump

Code 3400

OIL HAND PUMP 0,2 LITRES/CYCLE with METER

Hand pump for change and differential oil. It is equipped of a telescopic shanke suitable for 200 litres drums. It can delivery 0.2 litres for each cycle by 1.5 m length distributing hose, dispensing oil gun with rigid and no-drip valve terminal, electronic digital meter.



**Flow rate
0,2 litres for
each cycle**



Code 1700

BARREL HAND FOR OIL

- Capacity Barrell: 16 litres
- stroke flow rate: 0,13 litres
- hose 1,5 length and curved spout



**Flow rate
0,13 litres for
each cycle**

Air-operated grease pumps

Double-acting air-operated pumps suitable for high and medium pressure using all types of grease (fluid or thick) to short or long distance. All-aluminum body air motor. Grease pumping of ground steel and chrome, seals in special polyurethane.

Compression Ratio
R=50:1



AIR-OPERATED GREASE PUMP Ratio 50:1

Code 5040
Air-operated grease pump ratio 50:1 for 20 kg drums

Code 5060
Air-operated grease pump ratio 50:1 for 50 kg drums

Code 5080
Air-operated grease pump ratio 50:1 for 200 kg drums

Compression Ratio
R=10:1



AIR-OPERATED GREASE PUMP Ratio 10:1

Code 5041
Air-operated grease pump ratio 10:1 for 20 kg drums

Code 5061
Air-operated grease pump ratio 10:1 for 50 kg drums

Code 5081
Air-operated grease pump ratio 10:1 for 200 kg drums

Compression Ratio
R=100:1



AIR-OPERATED GREASE PUMP Ratio 100:1

Code 5042
Air-operated grease pump ratio 100:1 for 20 kg drums

Code 5062
Air-operated grease pump ratio 100:1 for 50 kg drums

Code 5082
Air-operated grease pump ratio 100:1 for 200 kg drums

Technical data	Code 5040	Code 5060	Code 5080	Code 5041	Code 5061	Code 5081	Code 5042	Code 5062	Code 5082
COMPRESSION RATIO	50 : 1	50 : 1	50 : 1	10 : 1	10 : 1	10 : 1	100 : 1	100 : 1	100 : 1
Air pressure using (bar)	2 - 8	2 - 8	2 - 8	2 - 8	2 - 8	2 - 8	2 - 6	2 - 6	2 - 6
Output pressure (bar)	400	400	400	80	80	80	600	600	600
Flow rate at 6 bar free exit (gr/min)	450	450	450	600	600	600	400	400	400
Air connection	1/4" F	1/4" F	1/4" F	1/4" F	1/4" F	1/4" F	1/4" F	1/4" F	1/4" F
Fluid connection	1/4" M	1/4" M	1/4" M	3/8" M	3/8" M	3/8" M	1/4" M	1/4" M	1/4" M
Grease NLGI	2/3	2/3	2/3	2/3	2/3	2/3	2/3	2/3	2/3
Pumping stem length (mm)	550	750	930	550	750	930	550	750	930
For drum capacity (Kg.)	20	50	200	20	50	200	20	50	200

Air-operated oil pumps

Double-acting air operated pumps for transferring **lubricant oil**, **exhausted oil** and **pure anti-freeze** to short or long distance. All-aluminum body air motor. Pumping oil in steel and rubber NBR with special polyurethane.

Compression Ratio
R=3:1

AIR-OPERATED OIL PUMP ratio 3:1

Code 5100
Air-operated oil pump ratio 3:1 for 200 kg drums

Code 5110
Air-operated oil pump ratio 3:1 for 50 kg drums

Code 5120
Air-operated oil pump ratio 3:1 for wall mounted

Code 5130
Air-operated oil pump ratio 3:1 for IBC 1000 litres TANK

Compression Ratio
R=6:1

AIR-OPERATED OIL PUMP ratio 6:1

Code 5200
Air-operated oil pump ratio 6:1 for 200 kg drums

Code 5210
Air-operated oil pump ratio 6:1 for 50 kg drums

Code 5220
Air-operated oil pump ratio 6:1 for wall mounted

Code 5230
Air-operated oil pump ratio 3:1 for IBC 1000 litres TANK

Technical data	Code 5100	Code 5110	Code 5120	Code 5130	Code 5200	Code 5210	Code 5220	Code 5230
COMPRESSION RATIO	3 : 1	3 : 1	3 : 1	3 : 1	6 : 1	6 : 1	6 : 1	6 : 1
Air pressure using (bar)	2 - 8	2 - 8	2 - 8	2 - 8	2 - 8	2 - 8	2 - 8	2 - 8
Output pressure (bar)	24	24	24	24	48	48	48	48
Flow rate at 6 bar free exit (l/min)	15	15	15	15	12	12	12	12
Air connection	1/4" F	1/4" F	1/4" F	1/4" F	1/4" F	1/4" F	1/4" F	1/4" F
Fluid connection	1/2" M	1/2" M	1/2" M	1/2" M	1/2" M	1/2" M	1/2" M	1/2" M
Oil entry connection	-	-	3/4"	-	-	-	3/4"	-
Pumping stem length (mm)	860	560	400	1000	860	560	400	1000
For drums capacity (litres)	200	50	wall	1000	200	50	wall	1000

Greaser

Steel greaser

AVP 11 SmPb37 - UNI EN 10204
White galvanized
(7 micron).
For every type of grease.

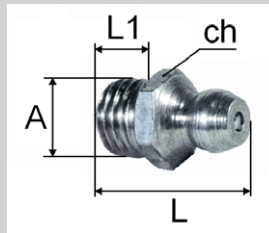

Dimensions

A= conical thread
ch= exagon key
L= total length
L1= thread length

Grease nipple for track circle head



Code	A	ch	L1	L
020/16x15	M 16x1,5 fiat	22	12	31
020/14G	G 1/4" BSP	22	12	31
020/38G	G 3/8" BSP	22	12	31



Hexagonal head with double hexagon
Tecalemit. In accordance with **UNI 7662 B**



Code	A	ch	L1	L
010/8x125	M 8x1,25	15	7	18
010/10x1	M10x1	15	7	18
010/10x15	M10x1,5.	15	7	18
010/18G	G 1/8" BSP	15	7	18
010/14G	G 1/4" BSP	15	7	18

HYDRAULIK grease nipple sphere head
In accordance with **UNI 7663 A**



Code	A	ch	L1	L
030/6x1	M 6x1	7	5	13,5

HYDRAULIK grease nipple sphere head
In accordance with **UNI 7663 A**



Code	A	ch	L1	L
040/6x1	M 6x1	7	6	30

HYDRAULIK grease nipple sphere head.
In accordance with **UNI 7663 A**



Code	A	ch	L1	L
060/12x15	M 12x1,5	15	7	18
060/12x175	M 12x1,75	15	7	18
060/14G	G 1/4" BSP	15	7	18

HYDRAULIK grease nipple sphere head
In accordance with **UNI 7663 A**



Code	A	ch	L1	L
050/6x1	M 6x1	9	6	17
050/7x1	M 7x1	9	6	17
050/8x1	M 8x1	9	6	17
050/8x125	M 8x1,25	9	6	17
050/10x1	M 10x1	11	7	19
050/10x125	M 10x1,25	11	7	19
050/10x15	M 10x1,5	11	7	19
050/18G	G 1/8" BSP	11	7	19

HYDRAULIK grease nipple 45°.
In accordance with **UNI 7663 A**



Code	A	ch	L1	L
070/6x1	M 6x1	11	6,5	25,5
070/7x1	M 7x1	11	6,5	25,5
070/8x1	M 8x1	11	6,5	25,5
070/8x125	M 8x1,25	11	6,5	25,5
070/10x1	M 10x1	11	6,5	25,5
070/10x125	M 10x1,25	11	6,5	25,5
070/10x15	M 10x1,5	11	6,5	25,5
070/18G	G 1/8" BSP	11	6,5	25,5
070/14G	G 1/4" BSP	11	6,5	25,5

HYDRAULIK grease nipple 90°.
In accordance with **UNI 7663 A**



Code	A	ch	L1	L
080/6x1	M 6x1	11	6,5	20,5
080/7x1	M 7x1	11	6,5	20,5
080/8x1	M 8x1	11	6,5	20,5
080/8x125	M 8x1,25	11	6,5	20,5
080/10x1	M 10x1	11	6,5	20,5
080/10x125	M 10x1,25	11	6,5	20,5
080/10x15	M 10x1,5	11	6,5	20,5
080/18G	G 1/8" BSP	11	6,5	20,5
080/14G	G 1/4" BSP	11	6,5	20,5

Grease Coupler

Code 6000 Coupler with 4 jaws
M10x1



Code 5990 Overtorned coupler for
grease nipples es. 15 mm - M10x1



Code 5980 Coupler with 4 jaws - 90°
M10x1



Code 5995 Giant coupler for tracks "ES. 22"
M10x1



Code 5985 Straight coupler for grease
nipples es 15 mm - M10x1

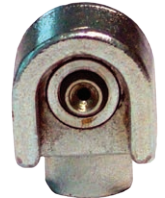

Code 5998 Conical nozzle "Lub" -
M10x1



Code 5996 Concave nozzle "Zerch" -
M10x1



Code 5993 Bended rigid tube - M10x1



Suction guns

Suction-pressure syringes for differential gear oil, brass body 1000 gr. capacity.

Code 14310
With rigid terminal



Code 14010
With flexible
terminal



Grease gun



Code 5950
Grease gun with 50 cm flexible hose
R2 1/4" and coupler

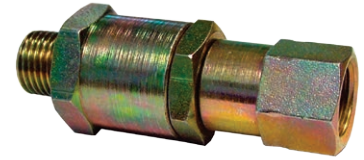

Code 6100 Straight swivel coupler M-F 1/4"



Code 5955
Grease gun with rigid bended
and coupler.



Code 5970
Grease gun.



Code 6110 Triple swivel coupler M-F 1/4"



Code 5945
GREASTER meter nozzle

GREASTER is an innovative grease dispensing gun equipped with an oval gear meter. Thanks to GREASTER the exact amount of grease dispensed by the nozzle is no longer measured according to an empirically method, but can accurately determined and displayed in a LCD..

Technical data

- Operating pressure: max 550 bar
- Burst pressure: min 1500 bar
- Metering accuracy: $\pm 3\%$
- Aluminum handle with stainless steel drive lever.



Nozzle and meters for oil



Code 5910

Oil gun with revolving connection **flexible extremity** and no drip valve.



Code 5930

Oil gun with revolving connection, digital meter, **flexible extremity** and no drip valve, rubber protection.

Code 5915

Oil gun with revolving connection **rigid extremity** and no drip valve.

Code 5935

Oil gun with revolving connection, digital meter, **rigid extremity** and no drip valve, rubber protection.



Code 5937 HIGH FLOW OIL GUN WITH METER

with revolving connection, **rigid extremity** and no drip valve, rubber protection.



Code 5937 HIGH FLOW OIL GUN

with revolving connection, **rigid extremity** and no drip valve.

Code 5502

From 6 to 60 litres/min capacity.
Inlet with 3/4" Gas.



DIGITAL METER

High-precision $\pm 0.5\%$ oval gear meter with easy-to-read display with 5 figures for partial volume and 8 figures non resettable total. 2x1,5 volt. battery power. Max pressure 70 bar. Rubber protection.

Code 5500

From 1 to 20 litres/min capacity.
Inlet with 1/2" Gas.



Code 5340

Electronic oil nozzle meter with PRESELECTION K500

Once the pre-selected quantity has been reached, the nozzle automatically closes the valve and stops dispensing. Flow rate from 1 to 30 l/min capacity. Accuracy 0.5 %. Pre-selectable quantity min 0.1 litres, max 99.9 litres. Inlet with 1/2" Gas swivel connector and incorporated filter. LCD with four-digit partial supply indicator (height 11.5 mm and non-resettable, six-digit total indicator (height 5 mm).
Powered by 4 (1.5v AA size) batteries.

Trolleys for drum

Handy trolley for drums transport built in sturdy tubular carbon steel frame with galvanized finish. Equipped with two fixed wheels and 2 swivel, it is ideal for handling drums.



Code 5600

4 wheels trolley suitable for **200 Kg.** drums

Code 5605

4 wheels trolley suitable for **200 Kg.** drums
with brake

Code 5625

4 wheels trolley suitable for **50 Kg.** drums

Code 5626

4 wheels trolley suitable for **50 Kg.** drums
with brake



Code 5630

4 wheels trolley suitable for 200 Kg. drums
with basin tank

Code 5635

4 wheels trolley suitable for 200 Kg. drums
with brake and basin tank



Followers plates and Drum Covers

THE FOLLOWER PLATE is necessary when high viscosity greases (NLGI 2-3) are used. The following advantages are granted:

- the compression of all grease excluding the formation of air pockets;
- the suction of all grease that otherwise would remain to the walls of the drum.

The follower plate with suitable for strongly tapered drums.

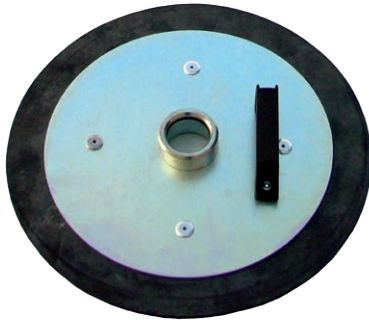

Code	external edge diameter	for internal diameter drum	for capacity drum	central diameter
73001	275 mm	280 mm	18 Kg	39 mm
73002	290 mm	290 mm	18 - 20 Kg	39 mm
7300	310 mm	290 mm 310 mm	18 - 20 Kg	39 mm
7303	330 mm	330 mm	25 Kg	39 mm
7305	350 mm	350 mm	50 Kg	39 mm
7310	390 mm	380 mm	50 Kg	39 mm

Heavy follower plate suitable for cylindrical drums and for consistent greases.



Code	external edge diameter	for internal diameter drum	for capacity drum	central diameter
7300H	290 mm	290 mm	18 - 20 Kg	39 mm
7310H	380 mm	380 mm	50 Kg	39 mm
7320H	590 mm	570 mm	180 Kg	39 mm
7330H	590 mm	570 mm	180 Kg	39 mm

THE DRUM COVER prevent impurities to mix the grease.
It is equipped of winged screws.

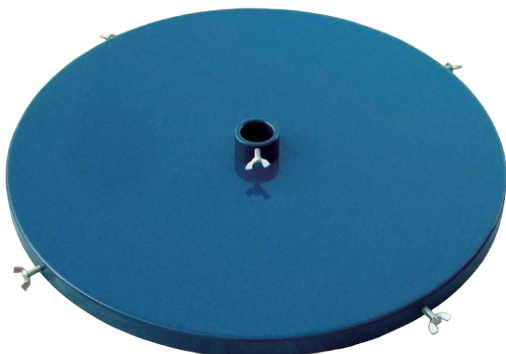

Code	Drum cover diameter	for external diameter drum	for capacity drum	central diameter
7400	315 mm	280 ÷ 310 mm	18 - 20 Kg	39 mm
7402	345 mm	310 ÷ 330 mm	20 - 25 Kg	39 mm
7410	400 mm	390 mm	50 Kg	39 mm
7420	600 mm	590 mm	180 Kg	39 mm
7430	600 mm	590 mm	180 Kg	56 mm

Accessories

Wall mounted oil dispenser equipped plugs cock with antispash filter.

Code 7198

Support single gun and oil collecting



Code 7900
with 3 plugs cock

Code 7901
with 4 plugs cock



Code 7830

Air lubricator and pressure regulator



Code 7850

Pressure regulator with manometer



Code 7820

Air lubricator and pressure regulator with condensate drainers and gauges



Code 7254

Rigid suction pipe
L= 700 mm Ø 1" (for 50 litres drums)

Code 7255

Rigid suction pipe
L= 900 mm Ø 1" (for 200 litres drums)

Code 7257

Rigid suction pipe
L= 1200 mm Ø 1" (for 1000 litres Tank)



Code 7915

Wall - fixing bracket

Code 7281

Telescopic shank 110 cm length



Automatic hose-reel



for GREASE

with hose SAE 100 R2AT- Ø 1/4"
(400 bar)



Code	hose length	connection thread
71900	15 mt	M-F 1/4"
71920	20 mt	M-F 1/4"
71930	25 mt	M-F 1/4"

code Swivel bracket
7194
7195
7196

R2 1/4" connection hose
2 m length. Connection
thread F-F 1/4".
Code 7115



for OIL

with hose SAE 100 R1AT-Ø 1/2"
(200 bar)



R1 1/2" connection hose
2 m length. Connection
thread F-F 1/2"
Code 7120

Code	hose length	connection thread
71901	15 mt	M-M 1/2"
71921	20 mt	M-M 1/2"
71931	25 mt	M-M 1/2"

code Swivel bracket
7194
7195
7196



for PRESSURE WASHER

with hose SAE 100 R16- 5/16"
(400 bar - 150 °C)



Code	hose length	connection thread
74402	15 mt	M 3/8" M 1/2"
74422	20 mt	M 3/8" M 1/2"
74432	25 mt	M 3/8" M 1/2"

code Swivel bracket
719410
719510
719610

Ø 5/16" connection hose
2 m length. Connection
thread F-F 1/2"
Code 70171

Automatic hose-reel

**for
DIESEL**

Connection thread
M-M 1"

with hose Ø 3/4"
(pressure 20 bar)

Code	hose length
75450	10 mt
75460	15 mt
75490	18 mt



Ø 1" connection
hose 2 m length.
Connection thread
F-F 1". Code 724850



with hose Ø 1"
(pressure 20 bar)

Code	hose length
75451	8 mt
75461	12 mt
75491	15 mt

code Swivel bracket
7195
71980
7197

**for
DIESEL**

stainless steel

Connection thread
M-M 1"

with hose Ø 3/4"
(pressure 20 bar)

Code	hose length
95950	10 mt
95960	15 mt
95840	18 mt



Ø 1" connection
hose 2 m length.
Connection thread
F-F 1". Code 724850



with hose Ø 1"
(pressure 20 bar)

Code	hose length
95951	8 mt
95961	12 mt
95841	15 mt

code Swivel bracket
719510
719710
719711

**for
AIR**

Code 7444

With hose length 15 m
hose Ø 8x12 mm
connection thread M 3/8"

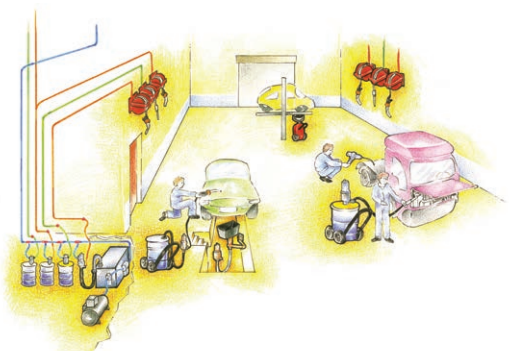

Hose

GREASE HIGH PRESSURE hose oil-resistant rubber, reinforced with 2 steel braids.
Operating pressure: 400 bar

DIAMETER 1/4"
(internal Ø 6,3 mm)

code	length (m)	connections
7090	0,5	M-M 10X1
7100	1	M-M 10X1
7105	1,5	M-M 10X1
7110	2	M-M 10X1
7115	2	F-F 1/4"
7018	4	F-F 1/4"
7020	6	F-F 1/4"
7030	8	F-F 1/4"
7040	10	F-F 1/4"
7050	12	F-F 1/4"

DIAMETER 1/4"
(internal Ø 6,3 mm)

code	length (m)	connections
7060	15	F-F 1/4"
7075	20	F-F 1/4"
7080	25	F-F 1/4"



OIL HIGH PRESSURE hose, oil-resistant rubber, reinforced with 1 steel braids.
Operating pressure: 160 bar

DIAMETER 1/2"
(internal Ø 12,7 mm)

code	length (m)	connections
7120	2	F-F 1/2"
7130	4	M-F 1/2"
7140	6	M-F 1/2"
7150	8	M-F 1/2"
7160	10	M-F 1/2"
7170	12	M-F 1/2"

DIAMETER 1/2"
(internal Ø 12,7 mm)

code	length (m)	connections
7180	15	M-F 1/2"
7188	20	M-F 1/2"
7189	25	M-F 1/2"



WASHER rubber hose, diam. 5/16", 400 bar, 100 °C, 3/8" M-F connection.

code	length (m)
7017I	3
7060I	15
7075I	20
7080I	25
7081I	30



Oil dispenser basin

Practical, convenient and safe system for the distribution lubricant oil from 200 litres commercial drums. Equipped of a containment basin is able to collect any accidental overflows by avoiding the environments dispersion. It is available with meter and several sizes of drums capacity.

Equipped of:

containment basin with frame, air-operated oil pump ratio 3:1, wall brackets, suction hose, distributing hose, air pressure regulator with condensate drainers and gauges, wall mounted oil dispenser equipped with 3 plugs cock with antisplash filter.

Code BC 2 BAR

Oil dispenser Basin for 2 drums

Code BC 3 BAR

Oil dispenser Basin for 3 drums

Code BC 4 BAR

Oil dispenser Basin for 4 drums



Available with hose-reel, high pressure hose 15 mt. electronic digital meter with flexible extremity.

Code BC 2 BAR AVV

Oil dispenser Basin for 2 drums with hose-reel

Code BC 3 BAR AVV

Oil dispenser Basin for 3 drums with hose-reel

Code BC 4 BAR AVV

Oil dispenser Basin for 4 drums with hose-reel



Oil dispenser basin for 1000 litres IBC Tank

SAFETY AND PRACTICALITY IN LUBRICANT SUPPLY OPERATIONS

Practical, convenient and safe system for the distribution of lubricants directly from commercial IBC containers of 1000 litres. Equipped of a containment basin is able to collect any accidental overflows by avoiding the environments dispersion; built in carbon steel sheet, epoxy powder coated and supporting surface in galvanized sheet metal. Possibility of moving by pallet truck or forklift.

Composed of:

- Containment basin for 1000 litres tank with supporting structure for hose reels
- Pneumatic oil pump for 1000 litres tank
- Lubricator and pressure regulator
- Hose reel with delivery hose length 15 mt
- Pump / hose reel connection pipe L = 2 mt
- Oil gun with electronic flow meter

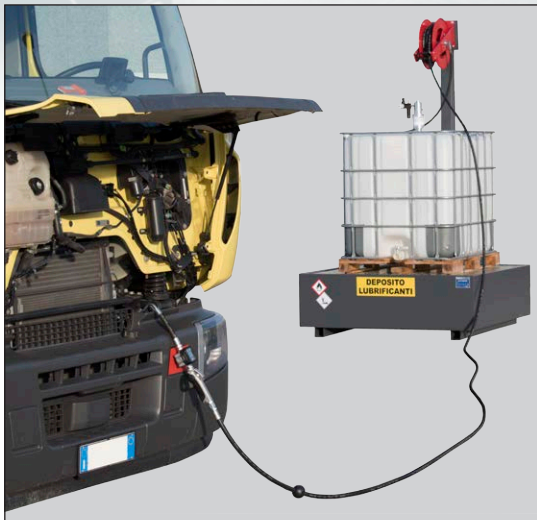

Code 23003

OIL DISPENSER BASIN FOR 1000 LITRES TANK

Pump compression Ratio R=3:1

Code 23004

OIL DISPENSER BASIN FOR 1000 LITRES TANK

Pump compression Ratio R=6:1

Plan Dimensions: 1500 x 1500 mm
Basin height: 450 mm - Overall height: 2600 mm

Containment basin



Code BC1
Containment basin for 1 drum
WxDxH: 900x900x260 mm

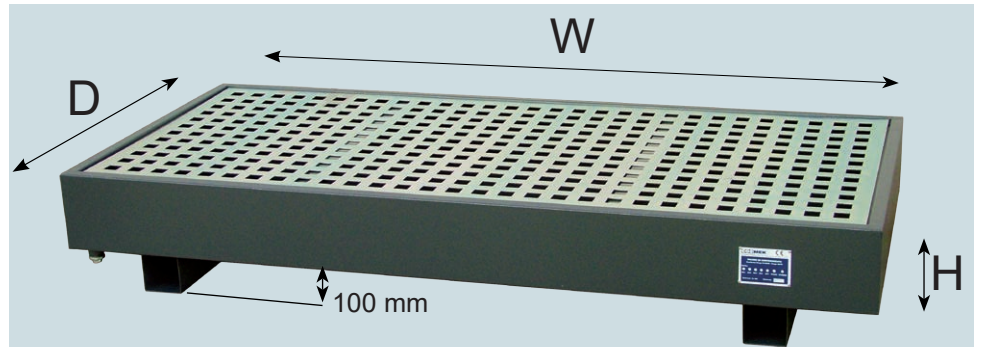

They are able to collect any accidental overflows by avoiding the environments dispersion. They are manufactured in carbon steel, painted with epoxy powders and galvanized plane.



Code BC2
Containment basin for 2 drums
WxDxH: 1500x900x260



Code BC3
Containment basin for 3 drums
WxDxH: 2000x900x200



Code BC4
Containment basin for 4 drums
WxDxH: 2800x900x200



Code BCT
Containment basin for 1000 litres tank
WxDxH: 1500x1500x450



Code BC4Q
Containment basin for 4 drums square
WxDxH: 1400x1400x200

Containment basin Box

FOR DEPOSITS OUT OF GROUND OF FLAMMABLE AND NON-FLAMMABLE LIQUIDS THAT CAN POLLUTE WATER



They are able to collect any accidental tracing by avoiding dispersion in the environments. Robust carbon steel frame, painted with epoxy powder. Container basin with pedestrian galvanized grid paving, protective roof, side closures with galvanized sheet metal walls, frontal opening, hanging closure, safety pictograms.



Container basin with grid





Code	External Dimensions width x depth x height (mm)	Capacity
BC2 BOX	1500 x 900 x h 2200	n°2 drums of 200 litres
BC3 BOX	2000 x 900 x h 2200	n°3 drums of 200 litres
BC4 BOX	2800 x 900 x h 2200	n°4 drums of 200 litres
BCT BOX	1500 x 1500 x h 2200	n°1 tank of 1000 litres
BCT2 BOX	2500 x 1800 x h 2200	n°2 tank of 1000 litres



Lubro-Box

Storage and distribution lubricant box

Ecological storage and distribution lubricating equipment. They are manufactured in carbon steel painted and galvanized plane. Frame equipment, lateral walls with top of galvanized sheet, single doors with handles and locks. They are able to collect any accidental overflows by avoiding the environments dispersion.



Internal view of BC BOX 60 (6000 x 2400 mm) - 4 Leaf

Code	Dimensions width x depth x height (mm)	Leaf number
BC BOX 30	3000 x 2400 x h 2400-2650	2
BC BOX 60	6000 x 2400 x h 2400-2650	4



Picture of BC BOX 30 (3000 x 2400 mm) - 2 Leaf



Shelves



Electrical system
And lighting



ramp (dimensions 1250 x 2500 mm)



Internal view of BC BOX 30 (3000 x 2400 mm) - 2 Leaf



Transportable

Tanks for diesel fuel transport and distributing, compliant with ADR regulations.

TRANSPORTABLE TANK with cylindrical horizontal axle (vertical for 250 and 450 litres) built in carbon steel, welded inside a strong chassis, roll away protection and impact resistance. Epoxy painted, equipped with bulkheads anti-slosh to limit the shaking of the liquid (only for 620 and 910 models). Hatch for internal inspection 400 mm diameter, tight with flange 10 mm thick with bolts and gasket. Safety valve diameter 3" according to law. Fusible plug protection of fire interior, coupling bronze 3" quick setting lockable. Eyebolts, hubs to forklift forks, anchoring holes at deck.

FUEL DISPENSING UNIT inside in metal box, with tamperproof lock and a dispenser nozzle bracket, self priming electric pump with bypass 12 or 24 VDC, flow rate 40 or 70 l/min, flow meter for private use with partial volume to 3 figures and progressive total to 6, flexible hose with connection 4 m. length, automatic nozzle with swivel coupling, connecting cable with pliers.



Capacity (litres)	Pump flow (l/min)	Weight (Kg)	Code
250	40	105	T250 GE40
	70	110	T250 GE70



Capacity (litres)	Pump flow (l/min)	Weight (Kg)	Code
380	40	133	T380 GE40
	70	138	T380 GE70



Capacity (litres)	Pump flow (l/min)	Weight (Kg)	Code
450	40	138	T450 GE40
	70	143	T450 GE70



Capacity (litres)	Pump flow (l/min)	Weight (Kg)	Code
620	40	149	T620 GE40
	70	154	T620 GE70



Capacity (litres)	Pump flow (l/min)	Weight (Kg)	Code
910	40	204	T910 GE40
	70	209	T910 GE70

Polyethylene tanks for diesel fuel transport

Polyethylene tanks series are light in weight, compact and easy to use. ideal for transporting and distributing diesel fuel.

Standard equipment includes:

loading aluminum cap with pressure relief valve, 12 VDC pump, flow rate 40 l/min, 4 m length delivery hose with automatic gun, 4 m cables with clamps to the battery. **Optional:** - digital meter - basin metal containment for 440 lt.



Code TC220 Tank 220 litres



Code TCB220PK Tank 220 litres shaped for pick-up vehicles. With lid.



Code TCB220 Tank 220 litres with lid

Code	Capacity (Litres)	Weigh Kg	Pump	Dimensions (mm)
TC220	220	24	40 l/min - 12 VDC	910 x 600 x 665 h
TCB220	220	28	40 l/min - 12 VDC	910 x 600 x 665 h
TCB220PK	220	30	40 l/min - 12 VDC	1140 x 800 x 665 h
TC440	440	52	40 l/min - 12 VDC	1200 x 800 x 785 h
TC440PK	440	57	40 l/min - 12 VDC	1200 x 800 x 830 h



Code TC440 Tank 440 litres



TC440 delivery group incorporated with locking lid



Code TC440PK Tank 440 litres shaped for pick-up vehicles



Code 5559
Electronic Digital flow meter (Optional)

Accessories related



Code BTC
Basin metal containment for TC440 (optional)

Tank for diesel with fuel dispenser box



TECHNICAL FEATURES

TANK

with cylindrical horizontal axle, fitted on anti-roll support brackets. Manufactured with top quality carbon steel S235JR UNI EN10025, submerged arc welded. Painted with epoxy powders, hydraulically tested and equipped of the following accessories:

- manhole diameter 420 mm with bolt and seals.
- 3" lockable rapid coupling ring-nut, with load-limiting valve calibrated at 90% of the tank geometric capacity.
- 1"-1/2 pressure relief valve with flame-breaker mesh - h= 2,40 m.
- Externally visible level gauge with inner protection hose for the float.
- stair of access to the load (only for CD50, CD60, CD90).
- drain sleeve with ball valve on the bottom by 3/4" and security cap.
- eyebolts.
- plug grounding and equipotentiality.
- external suction with non-return valve 1", ball valve 1" pipe and rigid connecting to the fuel dispensing unit.



FUEL DISPENSING UNIT

inside in metal box, with tamperproof lock and a dispenser nozzle bracket, self priming electric pump with bypass, flow rate 50 or 70 or 90 litres/min (230 VAC), flow meter for private use with partial volume to 3 figures and progressive total to 6, flexible hose with connection 6 m length, automatic nozzle with swivel coupling, IP 55 control panel with start-up device "Pump block" to lowest level.



CONTAINMENT BASIN

made of carbon steel sheet, self-supporting base frame already preset and bolted to the bottom of the tank, it can be placed on any type of ground, **with a capacity of not less than 110% of the overall geometric capacity.** Equipped with safety cap 1" suitable for fixing the uprights of the roofing. The basin is entirely painted with epoxy powder.



Pressure relief valve with flame-breaker mesh

Code	Capacity (litres)	Pump flow (l/min)	Dimensions (without roof) (WxDxH mm)
CD5/GE50/B5110%	498	50	1200X1200X1300
CD9/GE50/B9110%	992	50	1500x2000x1500
CD15/GE50/B15110%	1575	50	1500x2450x1500
CD23/GE50/B23110%	2273	50	1800x2450x1650
CD30/GE50/B30110%	3117	50	2100x2450x1800
CD49/GE50/B49110%	4942	50	2100x3200x2000
CD59/GE50/B59110%	5940	50	2400x3500x2200
CD90/GE50/B90110%	8960	50	2400x3900x2300

CD49/GE70/B49110%	4942	70	2100x3200x2000
CD59/GE70/B59110%	5940	70	2400x3500x2200
CD90/GE70/B90110%	8960	70	2400x3900x2300

CD49/GE90/B49110%	4942	90	2100x3200x2000
CD59/GE90/B59110%	5940	90	2400x3500x2200
CD90/GE90/B90110%	8960	90	2400x3900x2300

Tank for diesel with fuel dispenser box and "Ambrogio" management system



Computer with software management system

"Ambrogio"



1° VEHICLE
ENABLEMENT

2° DRIVER
ENABLEMENT

3° INSERTION OF
VEHICLE KILOMETERS

PUMP REFUELING
ENABLE



TECHNICAL FEATURES

TANK

with cylindrical horizontal axle, fitted on anti-roll support brackets. Manufactured with top quality carbon steel S235JR UNI EN10025, submerged arc welded. Painted with epoxy powders, hydraulically tested and equipped of the following accessories:

- manhole diameter 420 mm with bolt and seals.
- 3" lockable rapid coupling ring-nut, with load-limiting valve calibrated at 90% of the tank geometric capacity.
- 1"-1/2 pressure relief valve with flame-breaker mesh - h= 2,40 m.
- Externally visible level gauge with inner protection hose for the float.
- stair of access to the load.
- drain sleeve with ball valve on the bottom by 3/4" and security cap.
- eyebolts.
- plug grounding and equipotentiality.
- external suction with non-return valve 1", ball valve 1" pipe and rigid connecting to the fuel dispensing unit.



FUEL DISPENSING UNIT

inside in metal box, with tamperproof lock and a dispenser nozzle bracket, self priming electric pump with bybass, flow rate 50 or 70 or 90 litres/min (220 VAC), meter for private use with partial volume to 3 figures and progressive total to 6, flexible hose with connection 6 m length, automatic nozzle with swivel coupling, IP 55 control pannel with start-up device "Pump block" to lowest level.

READER TERMINAL

- illuminated graphic display, alphanumeric keypad, badge reader.
- Ability to refuel through double access: vehicle (key button) and user (badge).
- Requires entry of the number of km at the time of refueling.
- Stores: refueling date-time, driver, vehicle, Km and liters delivered at refueling.
- It has an autonomy of 4000 supplies without downloading the data.
- Possibility of coding and enabling up to 1500 cards.
- Connection to PC for data download via ETHERNET network connection with RJ45 or GPRS or LTE.
- Use the "AMBROGIO" software management system.

The AMBROGIO management system software: the registry of vehicles and drivers, refueling of vehicles, consumption averages, the cost per km of the vehicles, the stock of the tank, the supplies to the tank, the supplies outside the vehicles, enables and disable badges, and other functions.

All data can be printed with search functions.

CONTAINMENT BASIN

made of carbon steel sheet, self-supporting base frame already preset and bolted to the bottom of the tank, it can be placed on any type of ground, **with a capacity of not less than 110% of the overall geometric capacity**. Equipped with safety cap 1" suitable for fixing the uprights of the roofing. The basin is entirely painted with epoxy powder.

MANAGEMENT SYSTEM SOFTWARE AMBROGIO

The investment that returns.

- Know the consumption of the vehicles.
 - Know how much fuel there is in the company.
 - Prevent shortages or improper fuel withdrawals.
- These are useful information to take advantage of the work, with the pleasant feeling of control and savings.
- A great eye that watches over costs on a daily basis and the autonomy of the tank.

Code 4654

AMBROGIO management system software

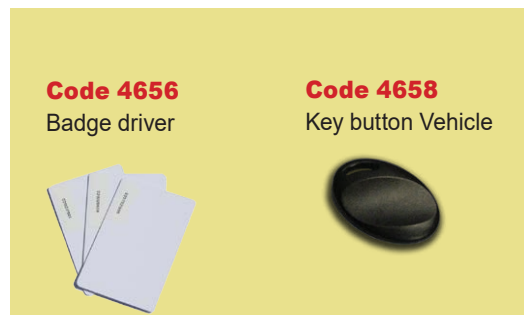
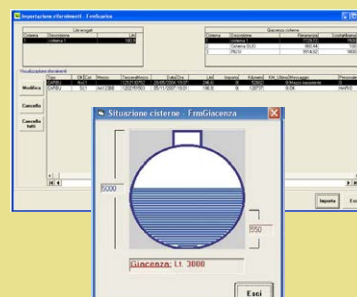

Code 4656
Badge driver

Code 4658
Key button Vehicle

Code	Capacity (litres)	Pump flow (l/min)	Dimensions (withou roof) (WxDxH mm)
CD49/GE50-4651/B49110%	4942	50	2100x3200x2000
CD59/GE50-4651/B59110%	5940	50	2400x3500x2200
CD90/GE50-4651/B90110%	8960	50	2400x3900x2300

CD49/GE70-4651/B49110%	4942	70	2100x3200x2000
CD59/GE70-4651/B59110%	5940	70	2400x3500x2200
CD90/GE70-4651/B90110%	8960	70	2400x3900x2300

Tank for diesel with Self-Service MC dispenser and management system

Only be used by
authorized persons with
code or a magnetic key
(80 users)



Store and export the
refilling on personal
computers

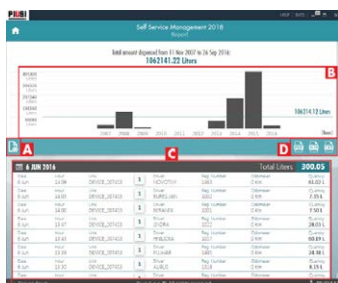

TECHNICAL FEATURES

TANK

with cylindrical horizontal axle, fitted on anti-roll support brackets. Manufactured with top quality carbon steel S235JR UNI EN10025, submerged arc welded. Painted with epoxy powders, hydraulically tested and equipped of the following accessories:

- manhole diameter 420 mm with bolt and seals.
- 3" lockable rapid coupling ring-nut, with load-limiting valve calibrated at 90% of the tank geometric capacity.
- 1"-1/2 pressure relief valve with flame-breaker mesh - h= 2,40 m.
- Externally visible level gauge with inner protection hose for the float.
- stair of access to the load.
- drain sleeve with ball valve on the bottom by 3/4" and security cap.
- eyebolts.
- plug grounding and equipotentiality.
- external suction with non-return valve 1", ball valve 1" pipe and rigid connecting to the fuel dispensing unit.



FUEL DISPENSING UNIT

Multi-user Self Service MC, only be used by authorized persons with code or magnetic key (max 80 users), with local memory of the last 250 performed dispensing operations, export data to PC allowing monitoring and verifying litres delivered. Equipped of 70 or 90 litres/min electric self-priming pump (220V/50 Hz motor) with line filter and bypass incorporated, high precision meter ($\pm 0.5\%$) for private use with digital display with date and hour, flexible hose 1" with connection 6 m length, automatic nozzle with swivel coupling, water separator filter, magnetic key reader on panel, control panel IP55 with pump shut down device at minimum level.

CONTAINMENT BASIN

made of carbon steel sheet, self-supporting base frame already preset and bolted to the bottom of the tank, it can be placed on any type of ground, **with a capacity of not less than 110% of the overall geometric capacity**. Equipped with safety cap 1" suitable for fixing the uprights of the roofing. The basin is entirely painted with epoxy powder.

The Distributor is equipped of:

- **code 12708**: For access to supplies by key users and data download to PC with key manager without the need for cable connection or
- **code 12710**: For data download to PC through cable connection up to 800 meters.

code 12708

Composed by:

Kit 10 user keys

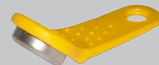

n.1 Manager key for data transfer on PC



n.01 Key player manager to connect to the PC and USB pendrive with software for managing supplies.



code 12710



Converter for direct connection to PC and USB pendrive software for handling supplies.



code 12494

Kit 10 user keys

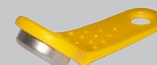

Features:

Enabling maximum 80 users, +/- 0.5% accuracy in the flow rate range, local storage of the deliveries performed, possibility of entering the vehicle code (registration number) and the mileage (odometer), management of the delivery date and time, yellow key magnetic for user recognition, data download on PC by means of: red manager key, via cable up to 800 meters away, via LAN, via Wi-Fi, via 4G.



Code	Capacity (litres)	Pump flow (l/min)	Dimensions (without roof) (WxDxH)
CD49/4690MC/B49110%	4942	70	2100x3200x2000
CD59/4690MC/B59110%	5940	70	2400x3500x2200
CD90/4690MC/B90110%	8960	70	2400x3900x2300

CD49/4695MC/B49110%	4942	90	2100x3200x2000
CD59/4695MC/B59110%	5940	90	2400x3500x2200
CD90/4695MC/B90110%	8960	90	2400x3900x2300

Tanks for diesel fuel depots without box fuel dispensing unit

Tanks serving thermal plants or generating sets.

TANK

with cylindrical horizontal axle fitted on anti-roll support brackets. Manufactured with top quality carbon steel S235JR UNI EN10025, submerged arc welded. Painted with epoxy powders, hydraulically tested and equipped of the following accessories: manhole diameter 420 mm with bolt and seals, 3" lockable rapid coupling ring-nut, with load-limiting valve calibrated at 90% of the tank geometric capacity, 1"-1/2 pressure relief valve with flame-breaker mesh. Externally visible level gauge with inner protection hose for the float, stair of access to the load (only for CD50, CD60, CD90), drain sleeve with ball valve on the bottom by 3/4" and security cap, eyebolts, plug grounding and equipotentiality.

Connection for fuel diesel suction:

1 nipple 1 "

2 sleeves female 1 "



CONTAINMENT BASIN

made of carbon steel sheet, self-supporting base frame already preset and bolted to the bottom of the tank, it can be placed on any type of ground, **with a capacity of not less than 110% of the overall geometric capacity.** Equipped with safety cap 1" suitable for fixing the uprights of the roofing. The basin is entirely painted with epoxy powder.

Code	Capacity (litres)	Dimensions (without roof) (WxDxH mm)
CD5/B5110%	498	1200x1200x1300
CD9/B9110%	992	1500x2000x1500
CD15/B15110%	1575	1500x2450x1500
CD23/B23110%	2273	1800x2450x1650
CD30/B30110%	3117	2100x2450x1800
CD49/B59110%	4942	2100x3200x2000
CD59/B59110%	5940	2400x3500x2200
CD90/B90110%	8960	2400x3900x2300

Tank for diesel

WITH MANUAL ROTARY PUMP



TANK

with cylindrical horizontal axle, fitted on anti-roll support brackets. Manufactured with top quality carbon steel S235JR UNI EN10025, submerged arc welded. Painted with epoxy powders, hydraulically tested and equipped of the following accessories: manhole diameter 420 mm with bolt and seals, 3" lockable rapid coupling ring-nut, with load-limiting valve calibrated at 90% of the tank geometric capacity, 1"-1/2 pressure relief valve with flame-breaker mesh. Externally visible level gauge, drain sleeve with ball valve on the bottom by 3/4" and security cap, eyebolts, plug grounding and equipotentiality, external suction with non-return valve 1", ball valve 1", pipe connecting to the fuel dispensing unit.

DISPENSING UNIT

equipped with a manual rotary pump 30 litres/m, flexible hose with connection 6 mt length, manual fuel nozzle with holder.

CONTAINMENT BASIN

made of carbon steel sheet, self-supporting base frame already preset and bolted to the bottom of the tank, it can be placed on any type of ground, **with a capacity of not less than 110% of the overall geometric capacity.** Equipped with safety cap 1" suitable for fixing the uprights of the roofing. The basin is entirely painted with epoxy powder.

Code	Capacity (litri)	Dimensions (Without roof) (WxDxH mm)
CD5/GEM/B5110%	498	1200X1200X1300
CD9/GEM/B9110%	992	1500x2000x1500
CD15/GEM/B15110%	1575	1500x2450x1500

Roofs

ROOF for protection against weather conditions, it is composed with fire-proof material. It is composed with a self supporting sturdy carbon steel frame, galvanized corrugated sheet covering which stick out from basin perimeter and it is provided with supports that can be quickly attached to the containment basin. Frame and support are completely painted with epoxy powder.

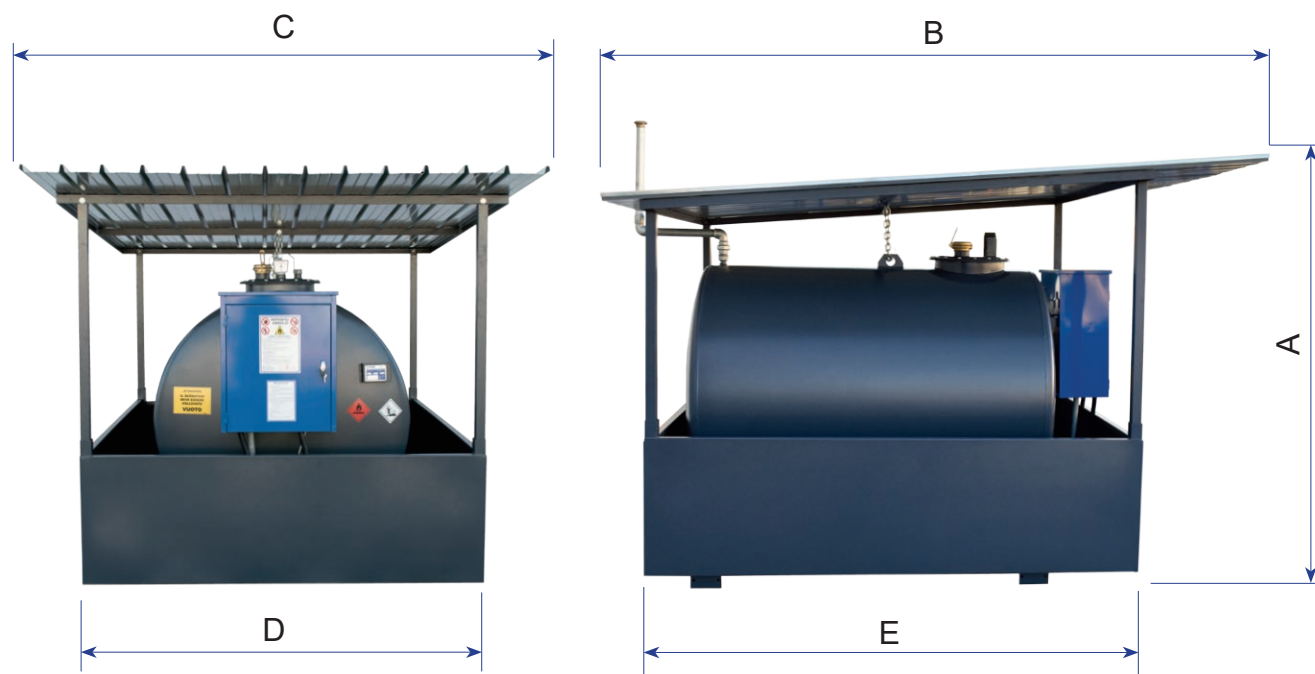

CODE	FOR BASIN	DIMENSIONS (mm) A x B x C	DIMENSIONS (mm) D x E
T5110%	B5 110%	2100 x 1480 x 1650	1200 X 1200
T9110%	B9 110%	2100 x 2420 x 1850	1500 X 2000
T15110%	B15 110%	2100 x 3000 x 1850	1500 X 2450
T23110%	B23 110%	2100 x 3000 x 2020	1800 X 2450
T30110%	B30 110%	2100 x 3000 x 2400	2100 X 2450
T49110%	B49 110%	2100 x 3890 x 2400	2100 X 3200
T59110%	B59 110%	2400 x 4000 x 2400	2400 X 3500
T90110%	B90 110%	2600 x 4500 x 2400	2400 X 3900

Enclosure closing

ENCLOSURE

with total locking on 4 sides, it is built with corrugated sheet and provided with lockable door for the access to the fuel dispensing unit.



code R5 110% Enclosure for CD 5 110%

code R9 110% Enclosure for CD 9 110%

code R15 110% Enclosure for CD 15 110%

code R23 110% Enclosure for CD 23 110%

code R30 110% Enclosure for CD 30 110%

code R49 110% Enclosure for CD 49 110%

code R59 110% Enclosure for CD 59 110%

code R90 110% Enclosure for CD 90 110%



Venting



Accessible interior for cleaning and maintenance

Double skin tanks for underground storage diesel fuel

Manufactured in accordance with UNI EN 12285-1 norms of 2003 class A

HORIZONTAL CYLINDRICAL TANK WITH DOUBLE WALL FOR UNDERGROUND DEPOSITS OF FLAMMABLE AND NON-FLAMMABLE LIQUIDS THAT CAN POLLUTE WATER. UNI EN 12285-1 2003 CLASS A.

Built in carbon steel (first sheet S235JR UNI EN 10025) with cylindrical horizontal axle, welded between the parties, It submitted for testing hydraulic tightness.



Cockpit adjustable in height

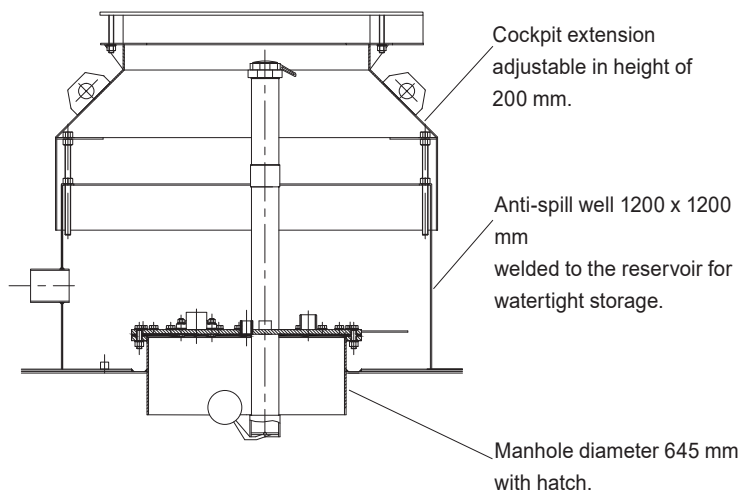

The cockpit tank adjustable in height with cast iron manhole for transit vehicles (400 KN) and opening SERVO-ASSISTED.

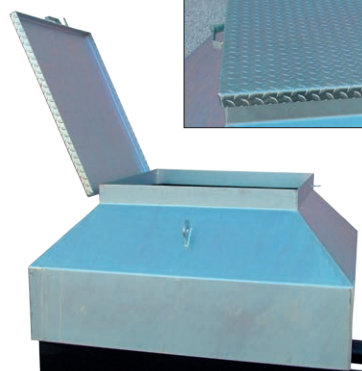
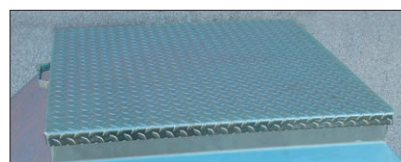

The cockpit tank adjustable in height with galvanized walkable plate.

FEATURES

- Manhole diameter 745 mm with connections, n° 24 bolt and seals.
- Load-limiting valve calibrated at 90% of the tank geometric capacity.
- 3" lockable rapid coupling ring-nut
- non-return valve 1" with pin overpressure and steel mesh filter.
- 1200x1200 mm anti-spill sump welded to the tank for the containment tank to contain any fuel spills during fuel loading.
- Cockpit extension adjustable in height from h = 900/1100 mm.
- Manhole cover in the models: WALKABLE (in striped plate with manual opening) or CARRIAGEABLE (in cast iron, 400 KN, with servo-assisted opening).
- Leakage control device (overpressure).
- External coating for the protection of the tank from chemical and electrochemical agents outside the ground.
- 2 collars 108 mm diameter welded to the front cockpit
- Eyebolts.
- Tank booklet, conformity, performance and test certificates.
- Level table.



	Tank capacity	External diameter	Tank Height	Tank Length	Wall thickness inner-outer	Tank Weight
Code	litres	mm	mm	mm	mm	kg.
SI3	3.000	1.600	2.650	1.650	5 + 3	900
SI4	4.000	1.600	2.650	2.250	5 + 3	1.000
SI5	5.000	1.600	2.650	2.700	5 + 3	1.200
SI6	6.000	1.600	2.650	3.200	5 + 3	1.400
SI8	8.000	1.600	2.650	4.200	5 + 3	1.700
SI9	9.000	1.600	2.650	4.700	5 + 3	1.900
SI10	10.000	1.600	2.650	5.200	5 + 3	2.000
SI12	12.000	1.600	2.650	6.200	5 + 3	2.500
SI15	15.000	2.000	3.050	5.000	6 + 3	2.900
SI20	20.000	2.000	3.050	6.600	6 + 3	3.600
SI25	25.000	2.000	3.050	8.300	6 + 3	4.500
SI30	30.000	2.500	3.550	6.500	6+4/5	5.000



Manhole with connections, n° 24 bolt and seals

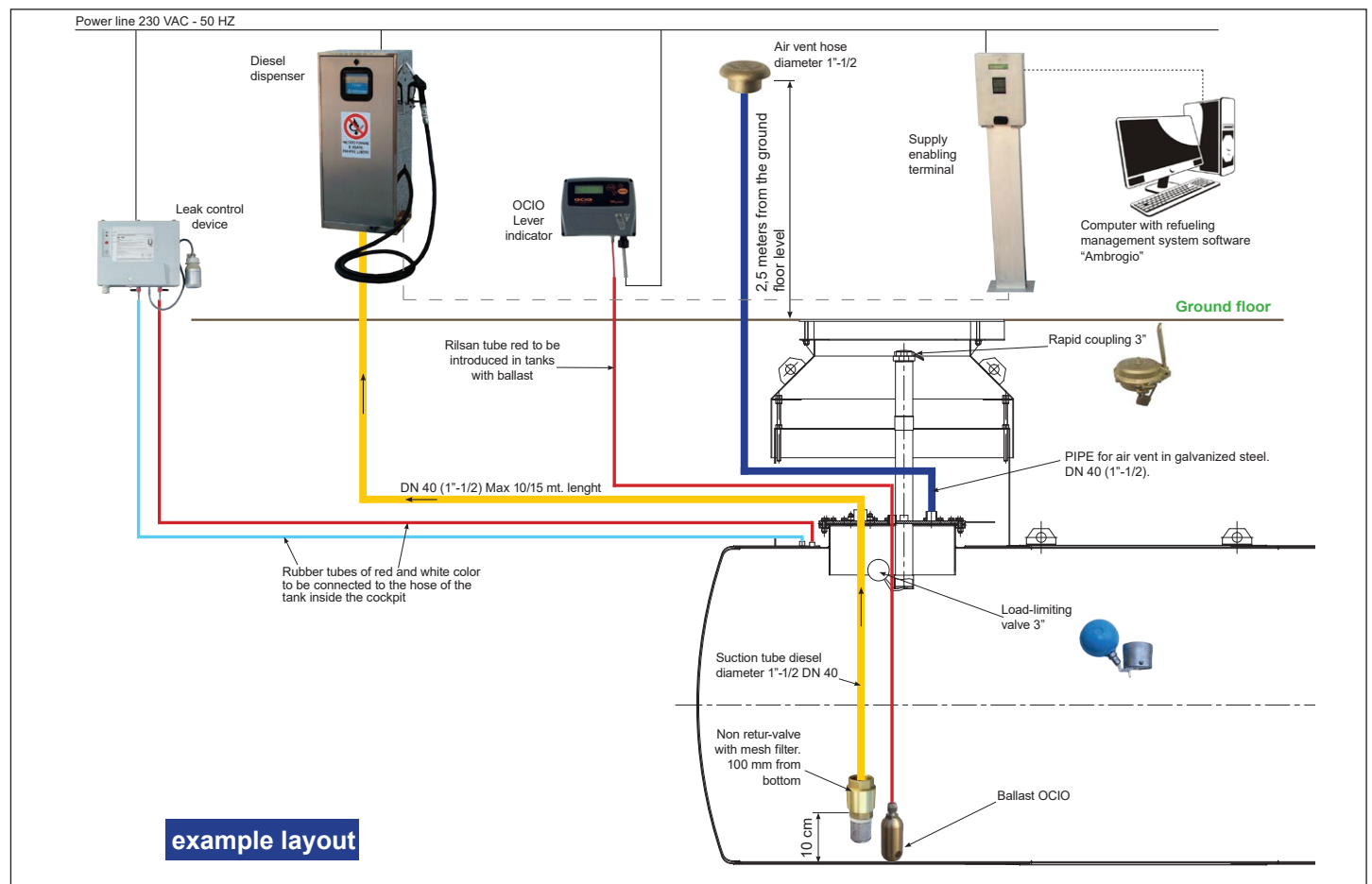

Double skin tanks for underground storage diesel fuel for heating systems



HORIZONTAL CYLINDRICAL TANK WITH DOUBLE WALL FOR UNDERGROUND DEPOSITS OF FLAMMABLE AND NON-FLAMMABLE LIQUIDS THAT CAN POLLUTE WATER.

Made of carbon steel (first choice sheet S 235 JR) with horizontal cylindrical section, electro-welded between the parts, and subjected to a hydraulic seal test.

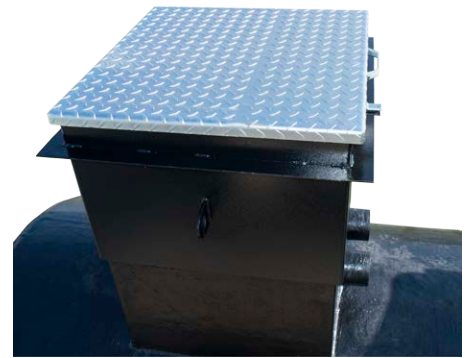

The cockpit tank adjustable in height with galvanized walkable plate.

Cockpit adjustable in height

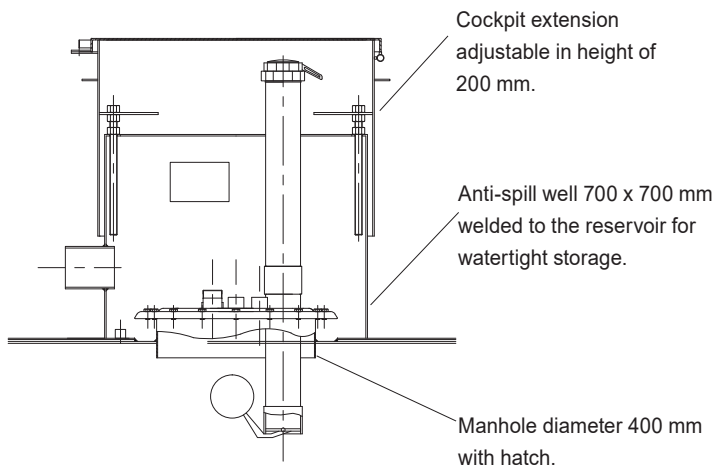

FEATURES

- Manhole diameter 400 mm with connections, n° 16 bolt and seals.
- Load-limiting valve calibrated at 90% of the tank geometric capacity.
- 3" lockable rapid coupling ring-nut
- 1"-1/2 pressure relief valve with flame-breaker mash.
- 700x700 mm anti-spill sump welded to the tank for the containment tank to contain any fuel spills during fuel loading.
- Cockpit extension adjustable in height from h = 750/950 mm.
- Manhole cover in WALKABLE model: striped plate with manual opening.
- Leakage control device (overpressure).
- External coating for the protection of the tank from chemical and electrochemical agents outside the ground.
- 2 collars 108 mm diameter welded to the front cockpit
- Eyebolts.
- Tank booklet, conformity, performance and test certificates.
- Level table.

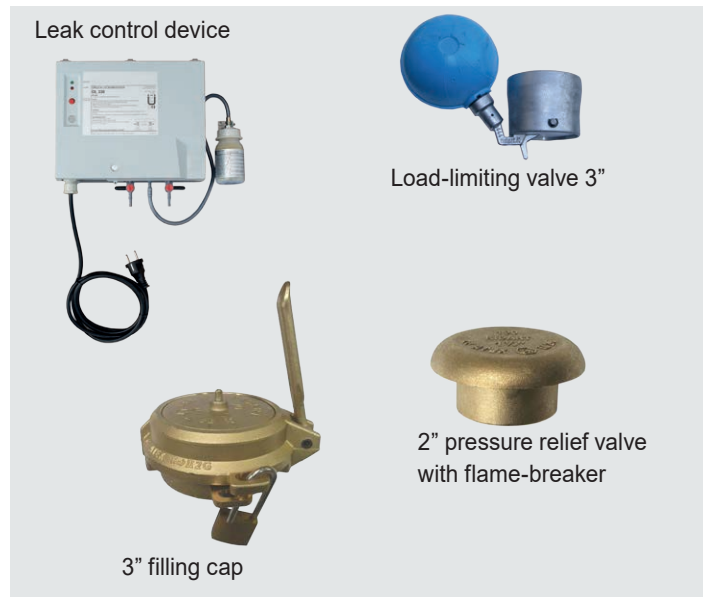

	Tank capacity	External diameter	Tank Height	Tank Length	Wall thickness inner-outer	Tank Weight
Code	litres	mm	mm	mm	mm	kg.
SI2.5R	2.500	1.600	2.350	1.400	5 + 3	800
SI3R	3.000	1.600	2.350	1.650	5 + 3	900
SI4R	4.000	1.600	2.350	2.250	5 + 3	1.000
SI5R	5.000	1.600	2.350	2.700	5 + 3	1.200
SI6R	6.000	1.600	2.350	3.200	5 + 3	1.400
SI8R	8.000	1.600	2.350	4.200	5 + 3	1.700
SI9R	9.000	1.600	2.350	4.700	5 + 3	1.900
SI10R	10.000	1.600	2.350	5.200	5 + 3	2.000
SI12R	12.000	1.600	2.350	6.200	5 + 3	2.500

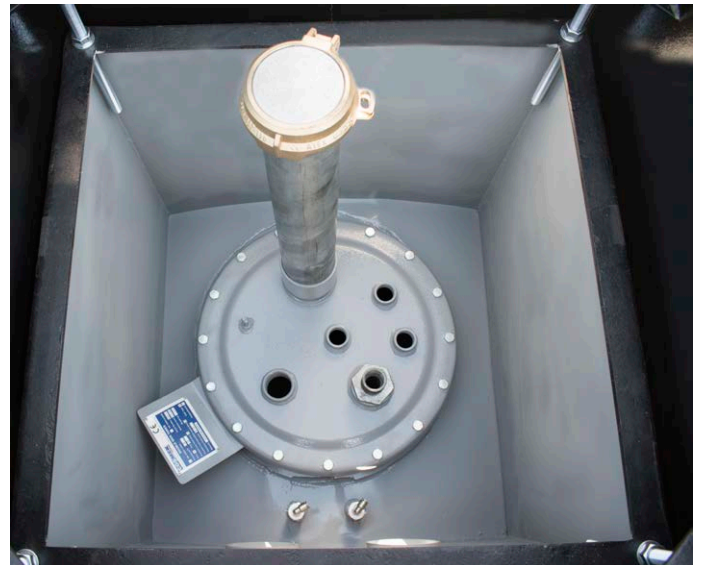

Double skin tanks for aboveground storage diesel fuel

Manufactured in accordance with UNI EN 12285-2 norms of 2005 class A



HORIZONTAL CYLINDRICAL TANK WITH DOUBLE WALL FOR ABOVEGROUND DEPOSITS OF FLAMMABLE AND NON-FLAMMABLE LIQUIDS THAT CAN POLLUTE WATER. UNI EN 12285-2 2005 CLASS A.

Built in carbon steel (first sheet S235JR UNI EN 10025) with cylindrical horizontal axle, welded between the parties, It submitted for testing hydraulic tightness.



FEATURES

- Manhole diameter 745 mm with outer flange thickness 15 mm, complete with rubber gasket, 24 bolts and flanges.
- 3" lockable rapid coupling ring-nut, with load-limiting valve calibrated at 90% of the tank geometric capacity.
- 1"-1/2 pressure relief valve with flame-breaker mesh
- External Level indicator
- Stair of access to the load
- 2 lifting handles.
- **Roll-away support saddles in accordance with UNI EN 12285**
- Hooks for anchoring
- Leak control device LAS 72 with glycol already in the cavity.
- Outer coating with anti-rust paint and finally a layer of enamel
- CERTIFICATE OF THE TIGHTNESS TEST, Metrics tables Identification plate.
- A wide range of dispensing unit

	Tank capacity	External diameter	Tank length	Wall thickness inner-outer	number saddle	Tank Weight
Code	litres	mm	mm	mm	n°	Kg
CDE3	3.000	1.600	1.700	5 + 3	2	900
CDE4	4.000	1.600	2.550	5 + 3	2	1.000
CDE5	5.000	1.600	2.850	5 + 3	2	1.200
CDE6	6.000	1.600	3.200	5 + 3	2	1.400
CDE8	8.000	1.600	4.200	5 + 3	2	1.700
CDE9	9.000	1.600	4.800	5 + 3	2	1.900
CDE10	10.000	1.600	5.200	5 + 3	2	2.000
CDE12	12.000	1.600	6.200	5 + 3	2	2.500
CDE15	15.000	2.000	5.000	6 + 3	2	2.900
CDE20	20.000	2.000	6.600	6 + 3	2	3.600
CDE25	25.000	2.000	8.300	6 + 3	2	4.500
CDE30	30.000	2.500	6.500	6 + 4/5	2	5.000



Fuel dispenser box with:

- electric pump
- digital fuel meter
- filter
- flexible hose with connection 6 m length
- automatic nozzle with swivel
- on/off electric switch



Ladder



Multi user diesel fuel dispenser CUBE MC:

- electric pump
- digital fuel meter with multi user dispenser
- flexible hose with connection 6 m length
- automatic nozzle with swivel
- on/off electric switch
- kit user keys with software

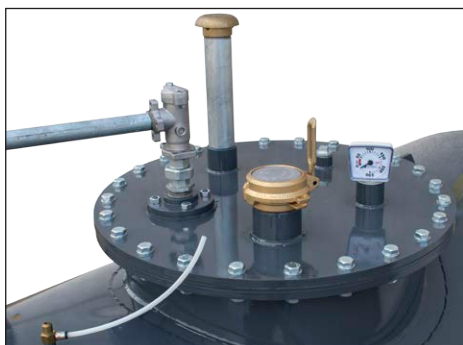

Manhole with connections, n° 24 bolt and seals



Leak control device



Support saddles UNI EN 12285 - 2

Ambrogio

Management System



Code 4656 User badge



Code 4658 Vehicle badge



Code 4651
Terminal reader

PERFORMANCES

- Ability to refuel through double access: vehicle (key button) and user (badge).
- Requires entry of the number of km at the time of refueling.
- Stores: refueling date-time, driver, vehicle, Km and liters delivered at refueling.
- It has an autonomy of 4000 supplies without downloading the data.
- Possibility of coding and enabling up to 1500 cards.
- Connection to PC for data download via ETHERNET network connection with RJ45 or GPRS or LTE.
- Use the "AMBROGIO" software management system.

The AMBROGIO management system software: the registry of vehicles and drivers, refueling of vehicles, consumption averages, the cost per km of the vehicles, the stock of the tank, the supplies to the tank, the supplies outside the vehicles, enables and disable badges, and other functions.

All data can be printed with search functions.

TECHNICAL FEATURES

illuminated graphic display,
alphanumeric keypad, badge
reader.

Dimensions:

254 mm x 180 mm x 90 mm

Power supply: 220 volt / 50 Hz
+ buffer battery (with standby
function).

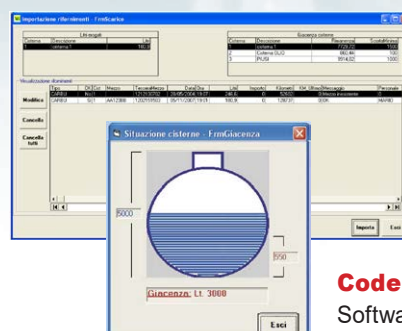

Code 4654
Software FUEL AMBROGIO

Computer with software management system

"Ambrogio"



1° VEHICLE ENABLEMENT

2° DRIVER ENABLEMENT

3° INSERTION OF VEHICLE KILOMETERS

PUMP REFUELING ENABLE



MANAGEMENT SYSTEM SOFTWARE AMBROGIO

The investment that returns.

- Know the consumption of the vehicles.
- Know how much fuel there is in the company.
- Prevent shortages or improper fuel withdrawals.

These are useful information to take advantage of the work, with the pleasant feeling of control and savings.

A great eye that watches over costs on a daily basis and the autonomy of the tank.

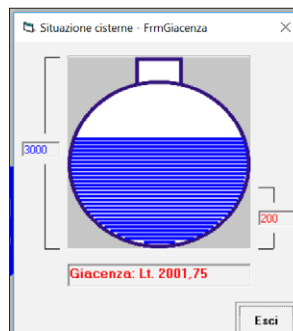

- The recognition of the refueling vehicle.
- The identification of the user taking the fuel.
- The storage of all data (vehicle, km of the vehicle, driver, liters dispensed, date and time) of each individual refueling.

The acquisition of these data will allow an immediate analysis of the costs of the vehicles, of the average kilometers, of the autonomy of the tank.

Tabulato costi carburante da data 01/01/2019 a data 06/11/2019

Codice	Descrizione	Targa	Media Km/Lt	osto chilometrico	KM percorsi
001	BMW 1		10,97	0,11	2.927
002	BMW 2		13,95	0,08	9.119
003	BMW 3		14,49	0,08	12.457
006	3 ASSI RENAUT		3,78	0,31	10.631
008	OPEL CORSA		17,62	0,07	9.610
005	FORD FURGONE		0,00	0,00	0
007	MEGANE FURGONE		18,17	0,07	4.938
004	RENAULT		7,29	0,16	13.926
009	MACCHINA		19,30	0,06	1.053
010	BMW 4		9,39	0,13	4.284
011	RENAULT		5,93	0,20	1.073

Stampa giornaliera rifornimenti analitica

Data	Ora	Cisterna	Codice	Modello	Targa	Kilometri	Litri	Importo	Autista
26/02/2019	15:28	1	001	BMW 1		104.599	31,97	36,63	Marco
28/02/2019	13:35	1	004	FURGONE RENAULT		112.394	53,92	61,78	ROBERTO
01/03/2019	12:00	1	004	FURGONE RENAULT		112.607	32,05	36,72	ROBERTO
01/03/2019	17:56	1	004	FURGONE RENAULT		112.909	39,10	44,80	ROBERTO
04/03/2019	17:05	1	002	BMW 2		41.095	57,25	65,60	MATTIA
06/03/2019	10:57	1	004	FURGONE RENAULT		113.308	62,38	71,48	ROBERTO
09/03/2019	08:10	1	003	BMW 3		37.739	41,70	47,78	STEFANO
13/03/2019	14:02	1	004	FURGONE RENAULT		113.765	65,19	74,69	ROBERTO
Totale:							383,56	439,48	

Container for waste oil

METAL CONTAINER FOR WASTE OIL

In accordance the European Directives 75/439/CEE 87/10/CEE regarding exhausted and waste oils disposal.

- Container for recovery of exhausted oil with containment basin of a cavity.
- **Capacity tank 500 litres.**
- Manufactured with top quality carbon steel S235JR.
- Painted with epoxy powders RAL 9005
- Chamber of drain used filters with grid, lid with handle and hinges
- Level indicator
- Hoof H= 100 mm for hand pallet truck
- Visual leak detector system
- Pictograms of signal and safety

Dimensions:

W 750 x D 750 x H = 1000 mm

Code SE500CK



Level indicator

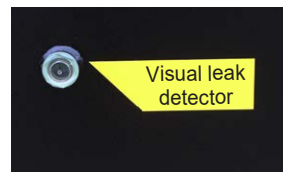

Visual leak detector



Chamber of drain used filters

POLYETHYLENE CONTAINER FOR WASTE OIL

In accordance the European Directives 75/439/CEE 87/10/CEE regarding exhausted and waste oils disposal.

Container for collection and storage of waste oil.

- Made of high-density polyethylene.
- Double wall tank.
- It's equipped with a lockable top hinged lid with inside a chamber for filter drainage.
- Top screwed hatch for drainage.
- Visual leak detector system.
- 2 available capacities: **300 litres - 500 litres**



Code	Dimensions (mm)	Capacity (Litres)
SE500	960 x h 1240	500
SE300	820 x h 1080	300



Level indicator



Chamber of drain used filters

Tank for waste oil

TANK with cylindrical horizontal axle, fitted on anti-roll support brackets. Manufactured with top quality carbon steel S 235 JR UNI EN 10025, submerged arc welded. Painted with epoxy powders, hydraulically tested and equipped of the following accessories: manhole diameter 420 mm with bolt and seals, hatch locking, load compartment/ unloading oil filters with grill, 1"-1/2 pressure relief valve with flame-breaker mesh. Externally visible level gauge with inner protection hose for the float, drain sleeve with ball valve on the bottom by 3/4" and security cap, eyebolts.

CONTAINMENT BASIN made of carbon steel sheet, self-supporting base frame already preset and bolted to the bottom of the tank, it can be placed on any type of ground, with a capacity of not less than 100% of the overall geometric capacity. Equipped with safety cap 1" suitable for fixing the uprights of the roofing. The basin is entirely painted with epoxy powder



Code	Capacity (litres)	Dimensions (without roof) (WxDxH mm)
SE1000	1000	1200x2000x1500
SE1500	1500	1400x2450x1500
SE2300	2300	1500x2450x1650



Chamber of drain used filters

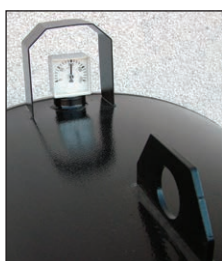

Level indicator



Code 545010
Kit Self loading pump



Code 545020
Kit self loading pump with basin wheeled oil drain
- Basin wheeled oil drain capacity: 70 litres
- Tank Dimensions: 800x560x180 mm

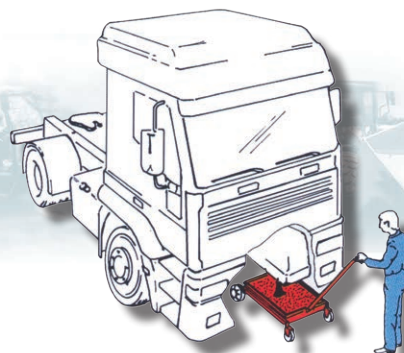

Environmental containers

Code CFO



DOUBLE ECOLOGICAL CONTAINER FOR USED FILTERS AND WASTE OIL

- Manufactured with top quality carbon steel S235JR.
- Container for recovery of exhausted oil **300 litres** with containment basin of a cavity, Chamber of drain used filters with grid, lid with handle and hinges, Level indicator.
- Container for recovery of used filters, grid drain with discharge on the bottom, Capacity **250 litres**.
- Hoof H= 100 mm for hand pallet truck
- Pictograms of signal and safety
- Painted with epoxy powders RAL 9005

Dimensions:

W 1200 x D 800 x H = 900 mm

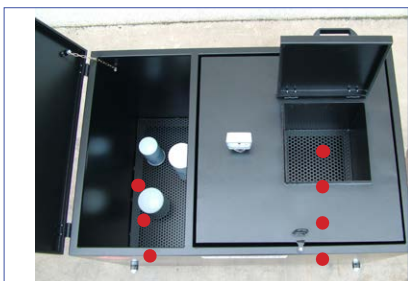

Filters container Oil container



Filters container Oil container



Code BCF



CONTAINER FOR USED FILTERS

- Manufactured with top quality carbon steel S235JR.
- Container for recovery of used filters, grille drain with discharge on the bottom.
- Capacity 800 litres.
- Lockable top hinged.
- Hoof H=100 mm for hand pallet truck.
- Pictograms signal and safety.
- Painted with epoxy powders RAL 9005

Dimensions:

W 1200 x D 800 x H = 800 mm



BATTERY CONTAINER

Polyethylene container for storing and handling batteries.

Resistant to acids, alkalis, and solvents in general.

Dimensions: 800 x 1200 x h= 700

Code BCA



SAFETY BASIN FOR CHEMICALS

Containment basin for the storage of hazardous chemicals.

Resistant to acids, alkalis, and solvents in general.

Suitable for 1000-liter IBC.

Dimensions: 1450 x 1450 x h= 1000

Capacity: 1100 liters

Code VPC



Waste oil recovery

Code 3800

Waste oil suction kit air operated with 70 litres wheeled basin capacity



Code 7540

Wheeled oil drain for underbody recovery basin capacity 70 litres

Code 75401

Wheeled oil drain for underbody recovery basin capacity 110 litres



Code 7541

Rolling oil drain for pit recovery 70 litres tank capacity

Code 75410

Rolling oil drain for pit recovery 110 litres tank capacity

Phytosanitary safety cabinets



Designed to meet all the latest requirements relating to the safe storage and disposal of phyto-pharmaceuticals and pesticides.

- Rugged galvanized steel frame, mad of cold-pressed steel sheet, thickness 12/10 mm.
- Hinged double front door, oven-baked powder coated, green-coloured, which grants a very smooth and resistant surface easily washable and sanitizable.
- Concealed handle with 3-points closure safety lock.
- Air grills for ventilation (on sides and top).
- Internal height adjustable shelves completed with extractable trays for spill collection.
- Safety sign indicating the presence of hazardous, toxic and corrosive products.



Code	Dimension (mm) Width x depth x height	Shelves	Weight (Kg.)
APK300	1000 x 480 x 1900	3	77



ventilation slots



Sign warning of toxic and harmful products



Lock - External

Fito-box

Phytosanitary products box

CONFORM TO D.M. Of 22/01/2014 IN IMPLEMENTATION OF DIRECTIVE 2009/128 / EC transposed by Legislative Decree no. 150 of 2012.

The ideal solution for the storage of plant protection products and other hazardous products, in accordance with the rules on the protection of human health, safety at work and the environment.



Code FITO BOX 2

Dimensions: width 2000 x depth 1400 x height 2400 mm



Code FITO BOX 1

width 1000 x depth 1400 x height 2400 mm



Technical data:

- Carbon steel structure with epoxy powder coating resistant to washing and atmospheric agents.
- Trays of pan type, 60 Kg.
- Ventilation holes.
- 2 Swing doors with handles and hanging closure.
- Hazard warning signs and emergency information.
- Bottom tank with galvanized support grid.
- Side walls and galvanized sheet cover.
- Lifting hoists and hoist h = 80 mm for hoisting.

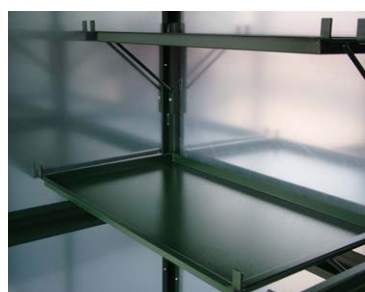

Shelves with removable tanks



Basin with grating

Multi-user diesel fuel dispenser

Diesel distributors for private use that can only be disbursed by authorized personnel with codes or magnetic keys. A dedicated software allows you to transfer data to a PC either by means of the magnetic key or by cable connection.



Code 4560

Distributor CUBE 70MC
70 l/min

Code 4690 MC

Distributor
Self Service 70MC
70 l/min.

Code 4695 MC

Distributor
Self Service 100MC
90 l/min.

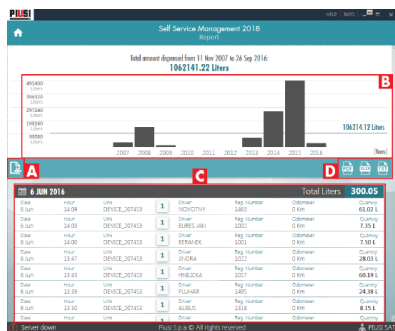

PERFORMANCE:

- 80 user for CUBE MC - 80 User for Self service MC
- Pre-selection dispensing.
- +/- 0.5 % precision within the flow-rate range.
- Local memory storage data for the last 255 deliveries. operations.
- Possibility for registration vehicle number and odometer.
- Dispensing date and time control.
- Magnetic key or code for user recognition.
- Special software for managing and printing operations.
- Possibility to transfer the data in a separate file.

EQUIPMENT

- Self-priming vane pump, equipped with bypass.
- Pump suction mesh filter and water separator filter.
- Pulsar meter with oval gears.
- Automatic nozzle with swivel connector and 4 m. diesel fuel hose
- Electronic unit with keyboard and display for registration of codes
- Key reader panel.

The Distributor is equipped of:

- **code 12708:** For access to supplies by key users and data download to PC with key manager without the need for cable connection

Or:

- **code 12710:** For data download to PC through cable connection up to 800 meters.

code 12708

Composed by:

n. 10 user keys

n. 1 Manager key for data transfer on PC.

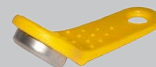

Key player Manager to connect to the PC, Usb pendrive with software for managing supplies.



code 12494

Kit 10 user keys

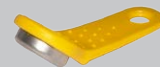

code 12710

Composed by:

Converter for direct connection to PC, Usb Pendrive with software for managing supplies.



Diesel fuel transfer unit



Code 4000

50 l/1' station wall with automatic nozzle.

Code 4100

70 l/1' station wall with automatic nozzle.

Code 4200

90 l/1' station wall with automatic nozzle.

TRANSFER UNIT

Equipped of:

Electric self-priming pump 50-70-90 l/min with line filter and bypass incorporated, 220V/50 Hz motor, flow meter for private use with progressive total to 6 figure and zeroing of partial volume to 3 figure, flexible hose with connection 4 m. length, automatic or self dispensing nozzle with swivel coupling, panel with pistol support or metal cabinet with switch on/off.



Code 4500

50 l/1' cabinet station wall with automatic nozzle.

Code 4570

70 l/1' cabinet station wall with automatic nozzle.

Self service K44 DIESEL FUEL DISPENSER

EQUIPMENT

- Self-supporting structure in painted and treated plate metal.
- Self-priming vane pump, equipped with bypass, installed on anti-vibration supports.
- Absorption filter for eliminating the water from the diesel fuel.
- Oscillating disk, volumetric, mechanical meter.
- Nozzle holder provided switch on-off applied on gun support
- Automatic nozzle with swivel connector and 4 m. diesel fuel hose.
- Electric panel housed in the structure for connection to the mains and low-voltage control of auxiliary components.

Water filter



Code 4650 SS

70 l/min self-service dispenser.

Code 4680 SS

90 l/min self-service dispenser.

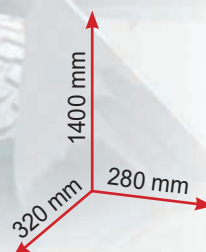

Distributor industrial series Fimac

Industrial distributor for private clients such as transporters, municipal, firefighters, army etc.. requiring a distributor like the road models.

TECHNICAL CHARACTERISTICS AND DOTATIONS:

- Volumetric shovel FIMAC vane pump with degassing unit, compact construction with body in stainless steel, adjustable bypass, filter and valves of don't return incorporate. Prevalence 5 meters. Capacity 50 or 80 litres/min.
- Explosion-proof electric motor with adequate power to the pump, feeding 380 V three-fase.
- Volumetric meter FIMAC four-piston, cast iron body, adjusting of each of the four pistons, accuracy $\pm 0.2\%$. high repeatability
- Head volumetric electronic single front that allows the display of litres provided for each operation and counter for the total metering dispenser (a liquid crystal display backlight)
- Steel stainless body shop.
- Automatic nozzle ZVA Elaflex.
- Professional dispensing hose 6 m. length
- Prepared for connection to managerial system

The hydraulic group FIMAC (pump and meter) is approved to metric level with certified CEE and the heads are all type approved to metric level.

code 4650 IND

FIMAC DISTRIBUTOR 50 l/min

code 4680 IND

FIMAC DISTRIBUTOR 80 l/min



Filter

The diesel filtration unit constitute an important guarantee to the protection of modern diesel motors that need cleaner motor fuel. The filter is mounted in suction or in delivery of the pump.



Code 7622
10 micron impurity filter and water separator

The main features of this filter are:

- separate and absorb water may be present in the diesel extracted.
- purify and decontaminate impurities in the fuel with a 10 micron capacity filter.

A reduction of the pump flow is due to its clogging that needs to be replaced.

Head with 1 "female.

Code 7632
Spare cartridge



Code 7620
30 micron impurity filter and water separator

The main features of this filter are:

- separate and absorb water may be present in the diesel extracted.
- purify and decontaminate impurities in the fuel with a 30 micron capacity filter.

A reduction of the pump flow is due to its clogging that needs to be replaced.

Head with 1 "female.

Code 7630
Spare cartridge



Cod. 7650

Cleaner Bio-Fuel

PureFuel Cleaner (PFC) A pre-filtration conditioner to reduce the effects of microbiological growth reduces filter blockage, fuel tank system corrosion and fuel injection problems.

Contamination of fuels, lubricating oils and hydraulic oils is now a common risk and causes extensive engine damage. THE BIOFUEL BLAST-FILLER fights microbial contamination and replaces the old and obsolete biocide chemical additive treatment practice. The installation of the BIOFUEL ABATTER increases the life of the fuel filters by 10 or more times, eliminates the blockage, prevents the formation of algae and reduces damage to the fuel tank coverings.

Pure fuel conditioner must be installed in a suction pump and before the unit filter.

Connections 1" female.

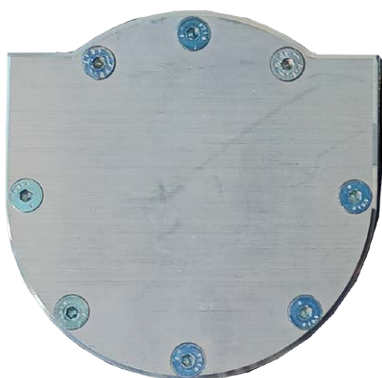

Self priming electric pumps

Self-priming electric pump with by pass valve built into pumps casing, electric box with switch on/off.



Code 5410

Electric pump for Diesel 50 litres/1' - 230 VAC

Code 5415

Electric pump for Diesel 70 litres/1' - 230 VAC

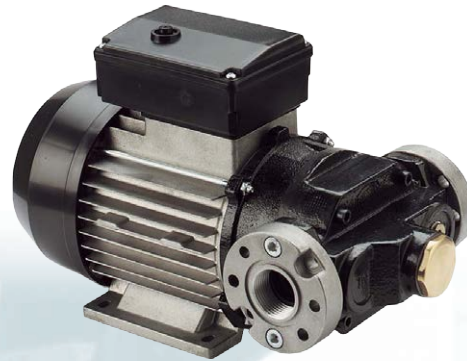

Code 5420

Electric pump for Diesel 70 litres/1' - 230 VAC

Code 5430

Electric pump for Diesel 90 litres/1' - 230 VAC



Code 54301

Electric pump for Diesel 140 litres/1' - 230 VAC

Code 54302

Electric pump for Diesel - Gasoline - Kerosene 100 litres/1' - 230 VAC - EX

Code 54303

Electric pump for Diesel - Gasoline - Kerosene 140 litres/1' - 230 VAC - EX

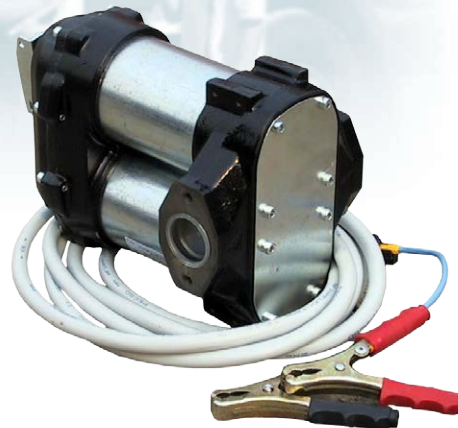

Code 4370

Electric pump for Diesel 70 litres/1' - 12 VDC

Code 4371

Electric pump for Diesel 70 litres/1' - 24 VDC



Code 430515

Electric pump for Diesel 40 litres/1' - 12 VDC

Code 430615

Electric pump for Diesel 40 litres/1' - 24 VDC

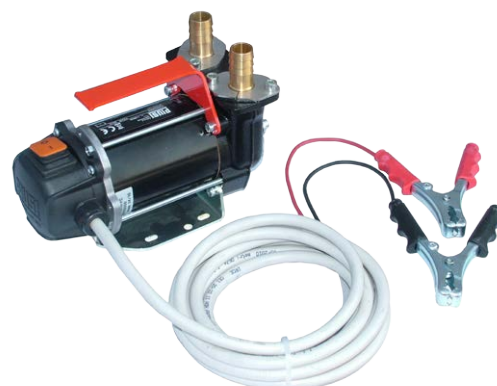

Code 4305

Electric pump for Diesel 40 litres/1' - 12 VDC

Code 4306

Electric pump for Diesel 40 litres/1' - 24 VDC

Self priming electric pumps



Code 5440

Electric pump for **oil** - **diesel** - **waste oil**
20 litres/1' - 6 bar - 230 VAC

Code 5445

Electric pump for **oil** - **diesel** - **waste oil**
40 litres/1' - 5 bar 230 VAC



Code 5435

Electric pump for **oil** 9 litres/1' - 12 bar - 230 VAC

Code 5436

Electric pump for **oil** 9 litres/1' - 25 bar - 230 VAC

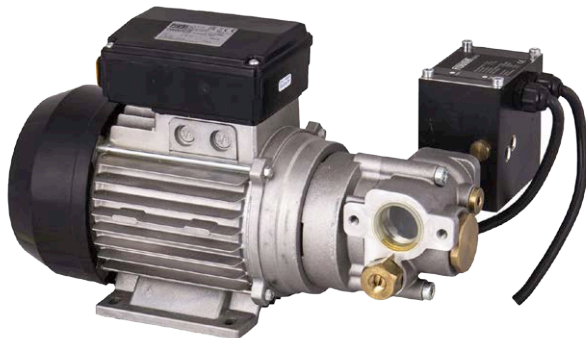

Code 5437

Electric pump for **oil** with a pressure switch.
9 litres/min - 12 bar - 230 VAC

Code 5438

Electric pump for **oil** with a pressure switch.
9 litres/min - 25 bar - 230 VAC



Code 54102

Electric pump for **Gasoline** 50 litres/1' - 12 VDC - **EX**
(DUTY CYCLE 30 minute)

Code 54104

Electric pump for **Gasoline** 50 litres/1' - 230 VAC - **EX**
(DUTY CYCLE 30 minute)



Code 5406

Electric pump for **aus32** - antifreeze - **water**
20 litres/1' - 12 VDC
(DUTY CYCLE 20 min)



Code 5405

Electric pump for **urea** - antifreeze - **water**
20 litres/1' - 230 VAC
(DUTY CYCLE 20 min)

Flow meters

Code 5510

MECHANICAL FLOW METER K33 FOR OIL - DIESEL

Precision $\pm 1\%$, resettable 3-digit subtotal, non resettable 6-digits total.
It works also for gravity. 1" gas female input/output. Aluminum body.



Code 5525

DIGITAL FLOW METER K600 FOR OIL - DIESEL

Precision $\pm 0,5\%$, non resettable 8-digit total display, and resettable 5-digits partial. Big display. Flow rate indication. Battery power 2x1,5 volt. 1" G input/output aligned. Aluminum body. Rotatable display.



Code 55101

MECHANICAL FLOW METER K33 - EX FOR GASOLINE

Precision $\pm 1\%$, resettable 3-digit subtotal, non resettable 6-digits total.
It works also for gravity. 1" gas female input/output. Aluminum body.



Code 5530

PULSER FLOW METER K600 FOR OIL - DIESEL

Precision $\pm 0,5\%$, for external pulse transmission and management of fluid dispensed. 35 signal pulses/litre, capacity 10-100 litri/min. 1" G input/output aligned. Aluminum body.



Code 5548

DIGITAL FLOW METER K24 FOR AUS32 - ANTIFREEZE - WINDSCREEN

Precision $\pm 1\%$, non resettable 6-digit total display, and resettable 5-digits partial. Battery power 2x1,5 volt.

1" G input/output aligned. Polyamide body.



Code 5559

DIGITAL FLOW METER K24 FOR DIESEL

Precision $\pm 1\%$, non resettable 6-digit total display, and resettable 5-digits partial. Battery power 2x1,5 volt.

1" G input/output aligned. Aluminum body.



Nozzles



Code 5800

Automatic nozzle for **DIESEL**, 60 l/min.

Code 5810

Automatic nozzle for **DIESEL**, 80 l/min.

Code 5820

Automatic nozzle for **DIESEL**, 120 l/min.



Code 5800 ZVA

Professional automatic nozzle, for **DIESEL** 60+80 l/min.

Code 5820 ZVA

Professional automatic nozzle, for **DIESEL** 80+140 l/min.



Code 5800B ZVA

Professional automatic nozzle, for **GASOLINE** 60+80 l/min.



Code 5870

Automatic nozzle for **AUS32** with meter.



Code 5880

Automatic nozzle for **AUS32**



Code 5701

Manual nozzle, plastic body, for **AUS32 - ANTIFREEZE - WINDSCREEN**



Code 59351

Manual nozzle with meter for **ANTIFREEZE - WINDSCREEN** 1/2" G female swivel connector.



Code 59352

Manual nozzle, plastic body, for **ANTIFREEZE - WINDSCREEN** 1/2" G female swivel connector.



Code 5700

Manual nozzle, aluminum body, for **OIL - DIESEL** 1" G female swivel connector.

Accessories

MANICHETTE IN GOMMA

Rubber high quality and resistance pipeline for distribution of **DIESEL** end **GASOLINE**, complete with detachable and reusable steel links.



Code	meters	Diameters
72606SL	6	3/4" (19x27 mm)
72608SL	8	3/4" (19x27 mm)
726010SL	10	3/4" (19x27 mm)
72706SL	6	1" (25x35 mm)
72708SL	8	1" (25x35 mm)
727010SL	10	1" (25x35 mm)

JOINABLE RUBBER HOSE

Antistatic rubber hose for distribution of **DIESEL**, crimped to the extremities with hose tails.



Code	meters	Diameters
7260	4	3/4" (19x27 mm)
72606	6	3/4" (19x27 mm)
7268	8	3/4" (19x27 mm)
7270	4	1" (25x35 mm)
72706	6	1" (25x35 mm)
7278	8	1" (25x35 mm)



Code 7615
Line filter



Code 400312
Collector flanged

Code 7200

Antistatic rubber hose for **DIESEL**
Ø 3/4" (Ø 19x27 mm)

Code 7210

Antistatic rubber hose for **DIESEL**
Ø 1" (Ø 25x35 mm)

Code 7201

Antistatic rubber hose for **UREA**
Ø 3/4" (Ø 19x27 mm)



Code 591090

SWIVEL 90° 1" M/F.



Code 3240

IBC attack with 1" hose



AUS32

Code 3260
Gravity Kit
Equipped of EPDM rubber hose 3 m length, 1000 litres IBC adapter, polyethylene manual nozzle.



Code 7962
1" foot valve
with foot filter



Code 7960
1" check valve

Ocio - Tank level indicator



Ocio is an innovative system for managing the level of liquid in atmospheric tanks. The system detects the static pressure generated by the height of the liquid by means of a tube introduced inside the tank and displays the liquid level on the display in a reliable and repeatable way. It has two level alarms that can be set as desired for the message on the display or for the control of remote signals (sound or visual).

Code OCIO - rs
OCIO - Terminal level indicator.

Code OCIO DESK 1
PC interface with software for 1 tank

Code OCIO DESK 4
PC interface with software for 4 tanks

Code OCIO DESK 8
PC interface with software for 8 tanks

Code OCIO DESK 12
PC interface with software for 12 tanks

It is also available direct connection to PC for remote management level in the tank through a dedicated software.

A new interface lets you connect up to 12 OCIO level gauges and send data by PC cable for a distance of up to 1000 meters.

Interface available for sending SMS to the 2 alarm levels set.

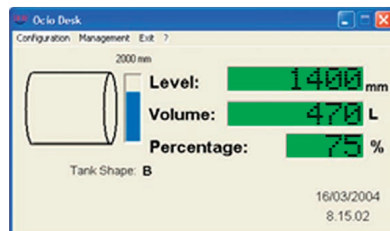

MC BOX - Multi user control panel



With this electronic panel, it is possible to authorize the withdrawal of fuel from a private distributor only to personnel using magnetic codes or keys (up to 80 users) and to transfer the data to a PC thus allowing the monitoring.

It is possible to enter automobile code and Km. Management of delivery date and time.

Dedicated software for managing and printing.

Code MCBOX

The MC BOX is equipped of:

- **code 12708**: for access to supplies by key users and data download to PC with key manager without the need for cable connection

Or:

- **code 12710**: For data download to PC through cable connection up to 800 meters.

code 12708

Composed by:

n. 10 user keys

n. 1 Manager key for data transfer on PC.



Key player Manager to connect to the PC, Usb pendrive with software for managing supplies.

code 12494

Kit 10 user keys

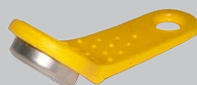

code 12710

Composed by:



Converter for direct connection to PC, Usb Pendrive with software for managing supplies.

Aqueous Urea Solution distributor

Complies with the stringent requirements of DIN 70070, CEFIC and Ec governing the handling and transfer of AUS32.



The new European directive 4/5 inherent the reduction of the issues of pollutants of the trucks in atmosphere, is respected through the installation of a catalyst on board of the mean (SCR) that asks the use of a special liquid denominated Urea AUS32 or AdBlue. Every truck will be provided of an additional reservoir to contain this liquid. So that the technology SCR post-treatment of the gases of unloading is effective it is essential to avoided any contamination of the urea for work of components and substances external out of the anticipated limits from the DIN 70070 and CEFIC norms.

If the decant system is not realized with compatible material, the SCR catalyst is damaged in irreversible way, physically stopping the pore or disarming the centres of chemical reaction. This provokes:

- 1) the increase of the polluting (NOx and NO2) issues.
- 2) secondary damages to the motor due to the increase of the gases pressure of unloading.

From a careful analysis of the tied up problems to the decant of this liquid, has been developed a reliable dispenser group built with material that are compatible with AUS32: pump, hose, links, nozzle etc. The dispenser has been conceived for being easy to install and to use. With extreme simplicity it can be removed by a reservoir to be moved on another. A precise litres-counter allows to check the disbursed quantity, while the closing automatic nozzle guarantees safety and simplicity in the decant.



Suction IBC



Automatic nozzle



Electric pump with On/Off switch



Litres-counter display

Standard equipment

- Metal box with easy access to the inside components, key lock, hooks for IBC frame anchoring.
- Self priming electric pump (230 VAC/50Hz) for AUS32, flow rate 20 l/min.
- Flow meter for AUS32 with digital display of easy reading.
- 5 m delivery hose for AUS32.
- Automatic nozzle for AUS32 with break-away system.
- on/off SWITCH and 2 m cable with socket.
- Suction hose from 1000 litres IBC tank

Code 4600

AUS32 distributor for IBC Tank 1000 litres

Code 4605

AUS32 distributor for IBC Tank 1000 litres without flow meter

Tank for Aqueous Urea Solution with dispenser box

Product meets the stringent requirements of DIN 70070, CEFIC and Ce that regulate the handling and transfer of AUS32



From a careful analysis of the problems related to the storage and handling of this fluid, it developed a high-density polyethylene tank equipped with an output unit reliable and built with materials compatible with the Aus 32: pump, hoses, fittings, gun etc. The brewing unit in the cassette is equipped with a precise meter that allows you to control the amount supplied, while the automatic closure of the gun guarantees safety and easy filling.

Standard equipment

- High density polyethylene tank.
- Metal box with easy access to the inside components, key lock.
- Self priming electric pump (230 VAC/50Hz) for AUS32, flow rate 20 l/min.
- on/off SWITCH and 2 m cable with socket.
- 4 m delivery hose for AUS32.
- Automatic nozzle for AUS32.

Code.	Capacity (litres)	Dimension (LxPxH mm)
SU2000	2000	1360x1550x1440
SU3000	3000	1600x1850x1660
SU5000	5000	1780x2320x1860



Automatic nozzle



Electric pump

with **automatic nozzle-meter**

Code.	Capacity (litres)	Dimension (LxPxH mm)
SU2000K24	2000	1360x1550x1440
SU3000k24	3000	1600x1850x1660
SU5000k24	5000	1780x2320x1860



Automatic nozzle-meter

Polyethylene tanks for Aus 32 transport

The standard equipment includes:

Charging cap with safety valve, 12 or 24 VDC electric pump, 20 l/min flow rate, 4 m delivery hose with automatic nozzle, 4 m electric cables with clamps for connection to the battery.

Optional: - digital flow meter on nozzle (**Code 5548**) - Sheet metal basin for version TC440 (**Code BTC**)



Code TC220U Tank 220 litres



Code TCB220U Tank 220 litres with lid



Code TC440U Tank 440 litres



Code TC440UPK Tank 440 litres shaped for pick-up vehicles

Wheeled tanks with manual rotary vane pump for AUS32, with plastic manual nozzle and 3 m of delivery hose.



Code TR55U Wheeled tank for 55 litres

Code TR110U Wheeled tank for 110 litres

Code	Capacity (Litres)	Weight Kg	Pump	Dimensions (mm)
TC220U	220	24	20 l/min 12 VDC	910 x 600 x 665 h
TCB220U	220	26	20 l/min 12 VDC	910 x 600 x 665 h
TC440U	440	42	20 l/min 12 VDC	1200 x 800 x 785 h
TC440UPK	440	42	20 l/min 12 VDC	1200 x 800 x 830 h
TR55U	55	9	manual	460 x 360 x 900 h
TR110U	110	13	manual	60 x 440 x 1100 h

Wheeled distributor for AUS 32

Code 3280

AQUEOUS UREA SOLUTION WHEELED DISPENSER

Transfer and fill the vehicle tanks with Aus 32 directly from the 210-liter commercial drums.

Composed by:

- Self priming electric pump (230 VAC/50Hz) for AUS32 flow rate 20 litres/min
- 4 m delivery hose for AUS 32
- AUTOMATIC NOZZLE WITH FLOW METER for AUS 32,
- 2 m suction hose with SEC connector
- Suction probe for drum
- 4-wheel trolley for carrying drums of 210 litres.



Automatic nozzle with integrated digital meter and protected by a resistant rubber shell.



RELATED ARTICLES

Art. 5870

Automatic nozzle.



Art. 5701

Manual nozzle



Polyethylene wheeled tanks for diesel and Gasoline

Ideal for refueling small operating vehicles and light or recreational vehicles.

Manual rotary vane pump with manual nozzle and 3 m of delivery hose.



Code	Capacity (Litres)	Weight Kg.	Pump	Dimensions (mm)
TR55	55	9	manual	460x360x900 h
TR110	110	15	manual	460x440x1100 h
TR55D	55	9	manual	460x360x900 h
TR110D	110	15	manual	460x440x1100 h

DIESEL

Code TR55D

Wheeled diesel tank 55 litres.

Code TR110D

Wheeled diesel tank 110 litres.

GASOLINE

Code TR55

Wheeled gasoline tank 55 litres.

Code TR110

Wheeled gasoline tank 110 litres.



Combined polyethylene tank for transport and distributing diesel fuel and AUS 32

Dotazioni:

- Pump 12 VDC, 40 lt/min for Diesel compartment.
- Submersible pump 12 VDC 15 lt/min for Aus 32 compartment.
- 4 m delivery hos with automatic nozzle for Diesel.
- 4 m delivery hose with manual nozzle for Aus 32.
- 4 m electric cables with clamps for connection to the battery
- level indicator (only diesel compartment).

General characteristics:

- Capacity Diesel compartment: 400 l
- Capacity Aus 32 compartment: 50 l
- Dimensions: 1200 x 800 x 785 h mm
- Dimensions (version Pick-up): 1200 x 800 x H 830 mm
- Empty weight with transfer units 12V: 57 Kg
- Wall thickness: 6,5 mm.



DIESEL

+

AUS32



Code TC400D50U

Combined Tank for Diesel and Aus 32

Code TC400D50UPK

Combined Tank for Diesel and Aus 32 shaped for pick-up vehicles

Oil purifier

Oil purifier- FILTER AND TRANSFER UNIT is the ideal tool for decontaminating oil by removing suspended particles. The unit's application is in situations where hydraulic systems or machinery lubrication requires that the circulating oil be free from impurities. The filtering unit is composed of a volumetric vane pump that suction the oil to be purified, sending it through a high-filtering capacity cartridge filter that removes the impurities.

The unit is equipped with helically wound transparent suction and discharge tubes for easy control of operations.

Filter clogging is revealed by a manometer installed on the filter head. Its support is wheeled for ease of movement and use.

Easy to use and maintain, it is the ideal piece of equipment to decontaminate oil simply and cleanly.

Performance

- Flow-rates from 25 to 30 l/min, according to the clogging of the filter.
- Continuous operation
- Noise less than 70 dB.
- Filtration Capacity.

Technical features;

- Wheeled tubular support structure with anti-corrosion treatment and paint finish for outside use.
- Self-priming volumetric vane pump, equipped with bypass.
- Self - ventilated, IP 55 induction motor, with thermal protection and cut-off switch.
- Interchangeable cartridge filter with head. Paper filter with filtering capacity of 10 micron. Supplied with one replacement cartridge.
- Manometer to signal filter clogging.
- Helically wound transparent suction and output tubing.



Code 4900 Oil purifier



REPLACEABLE CARTRIDGE

Cartridge filter with SPIN-ON in absorbent paper 10 microns

Code 7600 Cartridge filter 10 microns for oil purifier



DIESEL PURIFIER

STOP ALGAE, DIRT AND WATER IN DIESEL FUEL

Generally the percentage of biodiesel mixed with mineral diesel reaches 7% of the total.

Biodiesel is a fuel obtained from the refining of vegetable oils or animal fats. Because of its biological nature inside it live and develop bacteria that give life to colonies of micro-organisms called Diesel Algae.

These algae have a very fast reproduction, they feed on water and are able to do it autonomously because they make the diesel oil hygroscopic, that is able to absorb all the humidity present in the air like a sponge.

They also feed on:

- Metals (causing corrosion to tanks, tanks and internal parts of any engine);
- Diesel fuel hydrocarbons (causing the loss of the fuel's oxidising properties);

Developing it quickly and uncontrollably also causes the clogging of filters and the clogging of injectors or other system components.

This process takes place in a particularly aggressive manner inside the tanks of the vehicles and the storage tanks.

The evolution of engines that increasingly have to comply with regulations on emission reductions, then push to minimize solid and water contamination in diesel fuel.

From a careful analysis of the problem, COSMEK has developed an equipment to purify the diesel from dirt and water, and prevent the formation of algae.



Code 3865 DIESEL PURIFIER

Standard equipment

- Sturdy and compact TROLLEY with easy access to components in case of maintenance.
- SELF PRIMING ELECTRIC PUMP for diesel fuel, flow rate 90 L/min, 230 VAC, with on/off switch, suction pump protection filter.
- SUCTION HOSE 1", length 5 meters, with swivel joint with 3 degrees of freedom, check valve and safety pre-filter for the pump.
- DELIVERY HOSE 1", length 4 meters with swivel joint with 3 degrees of freedom.
- AUTOMATIC NOZZLE from 90 l/min.
- 3 Diesel fuel treatment units.



3 Diesel fuel treatment units

FIRST UNIT'

BIO-DIESEL CONDITIONER

Fuel contamination is now a common risk and causes extensive engine damage.

The BIO-DIESEL ABATHORM fights microbial contamination and replaces the old and obsolete biocide chemical additive treatment practice. The installation of the BIO-DIESEL ABATTER increases the duration of the fuel filters by 10 or more times, eliminates the blockage, prevents the formation of algae and reduces damage to the fuel tank coverings.

The magnetic action causes the plasmolysis of monocellular organisms bringing them to a state in which the cell is dormant.

The powerful magnetic field inside the biofuel conditioner breaks down the biomass in single cells smaller than one micron.

The sleeping cell does not produce adhesive shells and consequently will not form a colony (algae).

The plasmolized microbial material, being quite small, passes through the filters and is consumed by the engine during combustion.

Plasmolized microbes in the fuel returned to the tank remain in a dormant state for up to 28 days after treatment.

**This unit is
MAINTENANCE FREE**

SECOND UNIT

FILTER FOR SOLID PARTS 10 MICRON

The main feature of this filter is to purify and decontaminate the fuel from impurities present with a filtering capacity of 10 microns.

However, the purification causes a progressive reduction in the flow rate of the dispensing pump. When the filter is clogged, only the internal filter element must be replaced.

**Code 7632
Filter element
replacement**



THIRD UNIT

WATER ABSORBER FILTER

The main feature of this filter is that of separating and absorbing any water present in the pumped diesel fuel.

However, water absorption and purification cause a progressive reduction in the flow rate of the dispensing pump. When the filter is clogged it is necessary to replace the spin-on filter cartridge to lose.

**Code 7631
Cartuccia filtrante
di ricambio**



Wheeled dispenser for liquids

Pure antifreeze - Antifreeze with water - Windscreen



Code 3295 Wheeled dispenser for liquids

- Pure antifreeze
- Antifreeze with water
- Windscreen

Transfer directly from the 210-liter commercial drums.

Composed by: self priming electric pump (230 VAC/50Hz) flow rate 20 litres/min , 4 m delivery hose, MANUAL, 2 m suction hose with SEC connector, suction probe for drum, 4-wheel trolley for carrying drums of 210 litres.



Related article.
Nozzle with flow meter.
(Code 59351)

Transfer kit

Oil - Waste Oil - Diesel Fuel

The equipment is proposed as ideal for vacuuming and decanting in a simple, clean and rapid manner from one tank to another fluid such as oil, car oil and diesel. The unit is used in cases where the hydraulic or lubrication systems of the machines require that the oil be extracted and then replaced; or to empty diesel tanks.

Equipment: self priming electric pump (230 VAC/50Hz), on/off SWITCH and 2 m cable with socket, suction pump protection filter, 3 m suction hose with foot valve and prefilter; 4 m delivery hose, aluminium manual nozzle, handling trolley.

Code 32981 Transfer kit for **oil** - **waste oil**
flow rate 20 l/min

Code 32982 Transfer kit for **oil** - **waste oil**
flow rate 40 l/min

Code 32983 Transfer kit for **Diesel**
flow rate 70 l/min



Big-Bag door frame with bathtub

1000-litres Big-Bag Bag Holder.

Steel structure with epoxy powder coating consisting of:

- smoke less able to collect any accidental tracing and avoid dispersion in the environments.
- removable extensions.
- Top hatch with removable hooks for bag extraction.

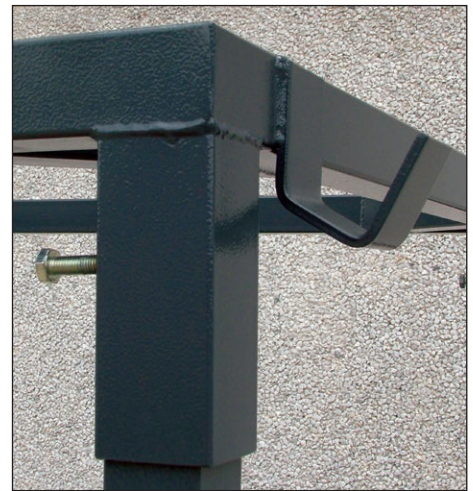

Code	Dimensions width x depth x height (mm)	Capacity
BC BIG BAG	1010 x 1010 x 2000	1 big bag 1000 litres

Accessories

Code 400410 Load-limiting valve.

Aluminum body.

Female G 3 "connection.



Code 400405 3" lockable rapid coupling ring-nut.

Brass body.

Female G 3 "connection.



Code 400412 Mechanical float level indicator with analog display.

Male Attack G 1 " -1/2.

Scale cm from 0-250.



Code 400408 Pressure relief valve with flame-breaker mesh.

Brass body.

Female Attack G 1 " -1/2.



Code 84500

Transversing filler for jerrican in steel.



Jerrican for gasoline in steel, **Approved according to regulations UN and certificate TUV**

Code 84750 Capacity 5 litres

Code 84700 Capacity 20 litres



PRESSURE SPRAYERS

Painted or stainless steel sprayer for spray cleaning, lubricating oils at low density. Independent operation after discharge of compressed air from 3 to 7 bar. Flow dependent from nozzle used. All models adopt a valve calibrated at 7 bar max. For all tanks is allowed to the filling 4 / 5 of the total capacity.



Code 33240

Stainless steel AISI 304 sprayer. **24 litres** capacity.



Code 33400

Stainless steel AISI 304 sprayer. **40 litres** capacity.



Code 33500

Painted steel sprayer. **40 litres** capacity.



Code 33250

Painted steel sprayer. **24 litres** capacity.

We may change or modify the features and dimensions of the products listed in this catalog, without notice, depending on the operational requirements or to improve their efficiency and quality. Any dimension considered critical should be verified with our technical office.

COSMEK

COS-MEK Srl - 37032 Monteforte d'Alpone (Verona) - Italy - Via Cappuccini, 9
Tel. +39 0457611776
e-mail: cosmek@cosmek.com
web: www.cosmek.com



Since 1972

